

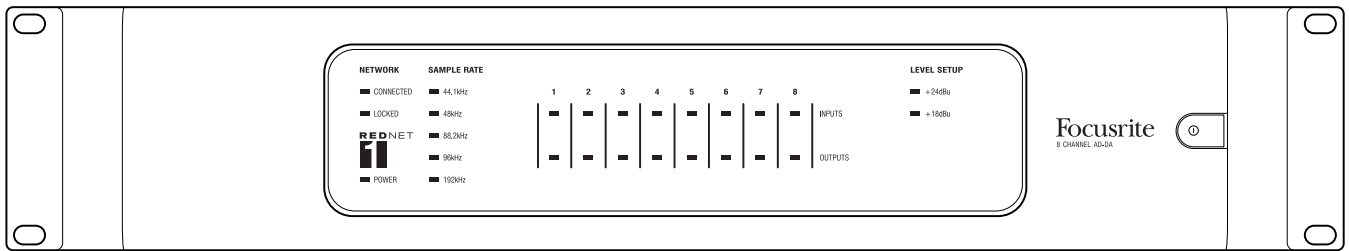

REDNET[®] 1

User Guide



Focusrite[®]
www.focusrite.com

IMPORTANT SAFETY INSTRUCTIONS

1. Read these instructions.
2. Keep these instructions.
3. Heed all warnings.
4. Follow all instructions.
5. Do not use this apparatus near water.
6. Clean only with dry cloth.
7. Do not block any ventilation openings. Install in accordance with the manufacturer's instructions.
8. Do not install near any heat sources such as radiators, heat registers, stoves, or other apparatus (including amplifiers) that produce heat.
9. Do not defeat the safety purpose of the polarized or grounding-type plug. A polarized plug has two blades with one wider than the other. A grounding type plug has two blades and a third grounding prong. The wide blade or the third prong are provided for your safety. If the provided plug does not fit into your outlet, consult an electrician for replacement of the obsolete outlet.
10. Protect the power cord from being walked on or pinched particularly at plugs, convenience receptacles, and the point where they exit from the apparatus.
11. Only use attachments/accessories specified by the manufacturer.
12.  Use only with the cart, stand, tripod, bracket, or table specified by the manufacturer, or sold with the apparatus. When a cart is used, use caution when moving the cart/apparatus combination to avoid injury from tip-over.
13. Unplug this apparatus during lightning storms or when unused for long periods of time.
14. Refer all servicing to qualified service personnel. Servicing is required when the apparatus has been damaged in any way, such as power-supply cord or plug is damaged, liquid has been spilled or objects have fallen into the apparatus, the apparatus has been exposed to rain or moisture, does not operate normally, or has been dropped.
15. No naked flames, such as lighted candles, should be placed on the apparatus.

The appliance coupler is used as the disconnect device, the disconnect device shall remain readily operable.

Do not use a damaged or frayed power cord.

If the mains plug supplying the apparatus incorporates a fuse then it should only be replaced with a fuse of identical or lower rupture value.

GB The apparatus shall be connected to a mains socket outlet with a protective earthing connection.

FIN Laite on liitettävä suojamaadoituskoskettimilla va rustettuumpistorasiaan

NOR Apparatet må tikoples jordnet stikkontakt

SWE Apparatens skall anslutas till jordat uttag



CAUTION
RISK OF ELECTRIC SHOCK
DO NOT OPEN



CAUTION: TO REDUCE THE RISK OF ELECTRIC SHOCK, DO NOT REMOVE COVER (OR BACK). NO USER-SERVICEABLE PARTS INSIDE. REFER SERVICING TO QUALIFIED SERVICE PERSONNEL.



The lightning flash with arrowhead symbol, within equilateral triangle, is intended to alert the user to the presence of uninsulated "dangerous voltage" within the product's enclosure that may be of sufficient magnitude to constitute a risk of electric shock to persons.



The exclamation point within an equilateral triangle is intended to alert the user to the presence of important operating and maintenance (servicing) instructions in the literature accompanying the appliance.

WARNING: TO REDUCE THE RISK OF FIRE OR ELECTRIC SHOCK, DO NOT EXPOSE THIS APPARATUS TO RAIN OR MOISTURE AND OBJECTS FILLED WITH LIQUIDS, SUCH AS VASES, SHOULD NOT BE PLACED ON THIS APPARATUS.

ENVIRONMENTAL DECLARATION

Compliance Information Statement: Declaration of Compliance procedure

Product Identification: Focusrite RedNet
 Responsible party: American Music and Sound
 Address: 4325 Executive Drive
 Suite 300
 Southaven
 MS 38672
 Telephone: 800-431-2609

This device complies with part 15 of the FCC Rules. Operation is subject to the following two conditions: (1) This device may not cause harmful interference, and (2) this device must accept any interference received, including interference that may cause undesired operation.

For USA

To the User:

- 1. Do not modify this unit!** This product, when installed as indicated in the instructions contained in this manual, meets FCC requirements. Modifications not expressly approved by Focusrite may void your authority, granted by the FCC, to use this product.
- 2. Important:** This product satisfies FCC regulations when high quality shielded cables are used to connect with other equipment. Failure to use high quality shielded cables or to follow the installation instructions within this manual may cause magnetic interference with appliances such as radios and televisions and void your FCC authorization to use this product in the USA.
- 3. Note:** This equipment has been tested and found to comply with the limits for a Class A digital device, pursuant to part 15 of the FCC Rules. These limits are designed to provide reasonable protection against harmful interference in a commercial environment. This equipment generates, uses and can radiate radio frequency energy and, if not installed and used in accordance with the instructions, may cause harmful interference to radio communications. Operation of this equipment in a residential area is likely to cause harmful interference in which the user will be required to correct the interference at his own expense

For Canada

To the User:

This Class A digital apparatus complies with Canadian ICES-003.
 Cet appareil numérique de la classe A est conforme à la norme NMB-003 du Canada.

RoHS Notice

Focusrite Audio Engineering Limited has conformed where applicable, to the European Union's Directive 2002/95/EC on Restrictions of Hazardous Substances (RoHS) as well as the following sections of California law which refer to RoHS, namely sections 25214.10, 25214.10.2, and 58012, Health and Safety Code; Section 42475.2, Public Resources Code.

TABLE OF CONTENTS

IMPORTANT SAFETY INSTRUCTIONS	2
INTRODUCTION	5
About this User Guide	5
Box Contents	6
INSTALLATION GUIDE	7
Unit Connections and Features	7
RedNet 1 - Front Panel	7
RedNet 1 - Rear Panel.....	8
Physical Characteristics	9
Power Requirements.....	9
OTHER REDNET SYSTEM COMPONENTS	10
USING REDNET CONTROL	10
APPENDIX	11
Connector Pinouts.....	11
Performance Specifications	13
Focusrite RedNet Warranty and Service	14
Registering Your Product	14
Customer Support and Unit Servicing	14
Troubleshooting	14

INTRODUCTION

Thank you for purchasing this Focusrite RedNet 1.

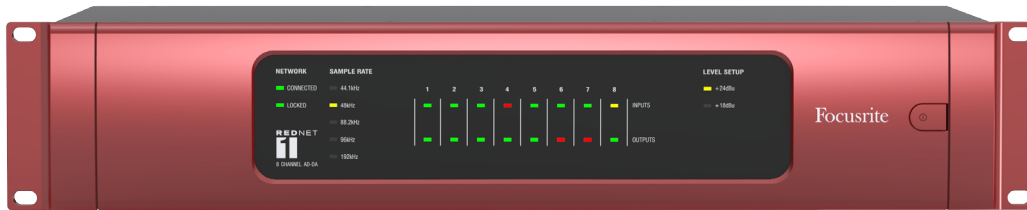

RedNet 1 is a multichannel, bidirectional analogue interface for use with a RedNet digital audio networking system.

RedNet is a powerful, low latency, digital audio networking system designed specifically for music, recording studio and broadcast applications. It is based on Audinate's Dante™, a well-established audio networking technology known for its extreme robustness. Dante - and the RedNet system - is capable of transporting up to 512 channels of bidirectional audio (at 48 kHz sample rate) over a single Gigabit Ethernet link. The number of channels available in your DAW will depend on the host method being used.

RedNet 1 provides eight analogue inputs and eight analogue outputs. A-D and D-A conversion is 24-bit at sample rates of up to 192 kHz, and up to 119 dB of dynamic range is achievable. JetPLL™ technology is employed to minimise conversion jitter.

The analogue inputs and outputs are electronically balanced on 25-pin Dsub connectors. The unit can be configured with 0 dBFS equating to either +18 dBu or + 24 dBu to conform to the EBU or SMPTE-RP155 standards respectively.

The front panel contains a set of LEDs confirming network status, sample rate, reference level and per-channel signal level.

About this User Guide

This User Guide applies only to the RedNet 1 analogue interface. It provides information about installing a RedNet 1 and how to connect it into your studio system.

You will also find a copy of the RedNet System User Guide included with the unit. This Guide provides a detailed explanation of the RedNet system concept, to help you achieve a thorough understanding of its capabilities. We recommend that all users, including those already experienced in digital audio networking, take the time to read through the System User Guide so that you are fully aware of all the possibilities that RedNet and its software has to offer.

If either User Guide does not provide the information you need, be sure to consult www.focusrite.com/rednet, which contains a comprehensive collection of common technical support queries.

Box Contents

- RedNet 1 unit
- RedNet 1 User Guide (this manual)
- RedNet System User Guide
- 2 m Cat6 Ethernet cable
- IEC AC mains cable
- Product registration card with Bundle Code. Registration gives access to:
 - RedNet Control
 - RedNet drivers (installed with RedNet Control)
 - Audinate Dante Controller (installed with RedNet Control)
 - Dante Virtual Soundcard token and download instructions
 - RedNet 1 User Guide (this document) – PDF format
 - RedNet System User Guide – PDF format

INSTALLATION GUIDE

Unit connections and features

RedNet 1 - Front Panel

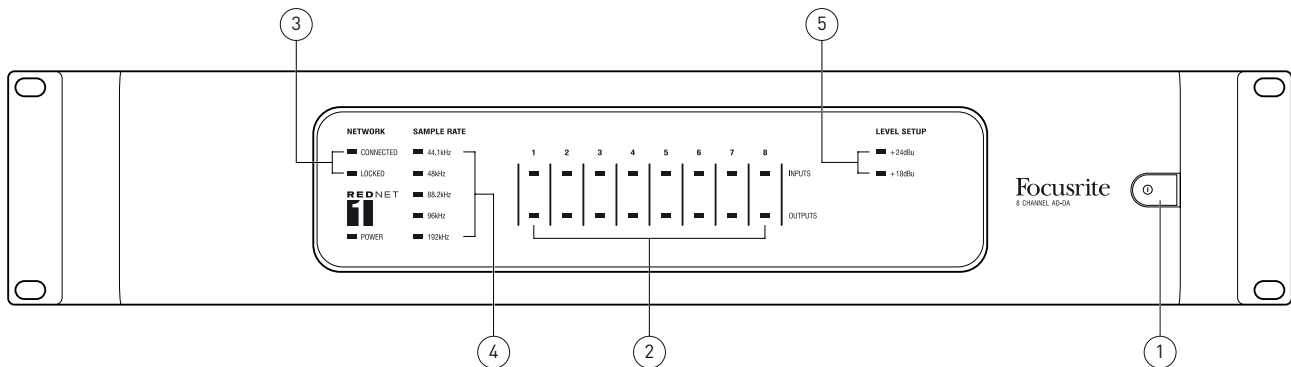

1. AC Power switch
2. Tricolour LEDs indicating signal level at each A-D and D-A converter:
 - Green – signal level above -42 dBFS
 - Yellow – signal level above -6 dBFS
 - Red – signal level is 0 dBFS (digital clipping)
3. **NETWORK** status flags – two green LEDs confirming network status:
 - **CONNECTED** – illuminates when the unit is connected to an active Ethernet network
 - **LOCKED** – illuminates when a valid sync is received via the network
4. **SAMPLE RATE** indication – five yellow LEDs; only one of these (**44.1 kHz, 48 kHz, 88.2 kHz, 96 kHz, 192 kHz**) will be lit at a time, to confirm the sample rate that the system is running at.
5. **LEVEL SETUP** indication – two yellow LEDs; one of these will be illuminated to confirm the analogue reference level set for the unit, **+24 dBu** or **+18 dBu**. This is the analogue level which equates to the internal maximum digital clip level of 0 dBFS.

RedNet 1 - Rear Panel

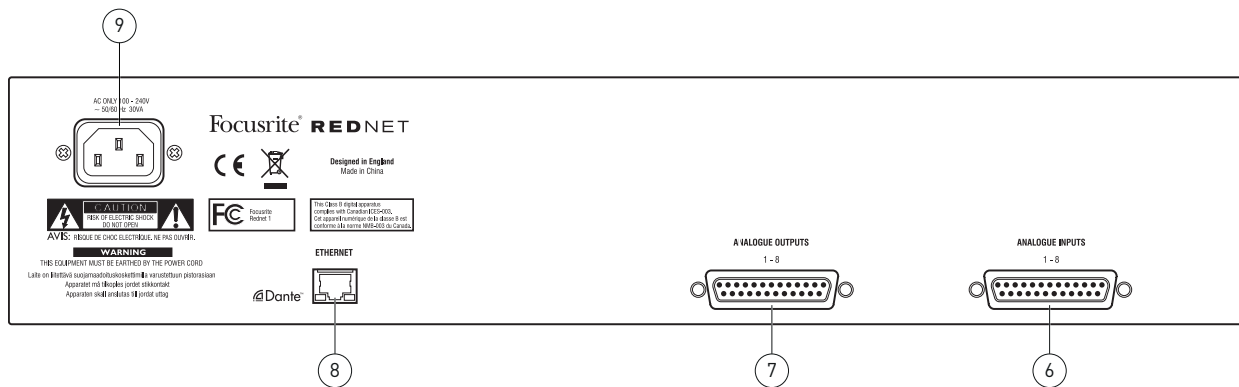

- 6. ANALOGUE INPUTS 1-8** – 25-pin female Dsub connector for connecting up to 8 analogue sources to the RedNet system. All inputs are electronically balanced. See page 11 for connector details.
- 7. ANALOGUE OUTPUTS 1-8** – 25-pin female Dsub connector with 8 analogue outputs from the RedNet system. All outputs are electronically balanced. See page 11 for connector details.
- 8. ETHERNET** – RJ45 network socket. Use a standard computer network cable to connect this socket to a local Ethernet switch to connect the RedNet 1 to the RedNet network. The socket has integral LEDs which illuminate to indicate connection to an active network port, and network activity. See page 12 for connector details.
- 9. AC mains** – standard IEC receptacle for connection of AC mains. RedNet 1 has a 'Universal' PSU, enabling it to operate from any supply voltages between 100 V and 240 V.

Physical Characteristics

RedNet 1's dimensions are shown in the diagram below:

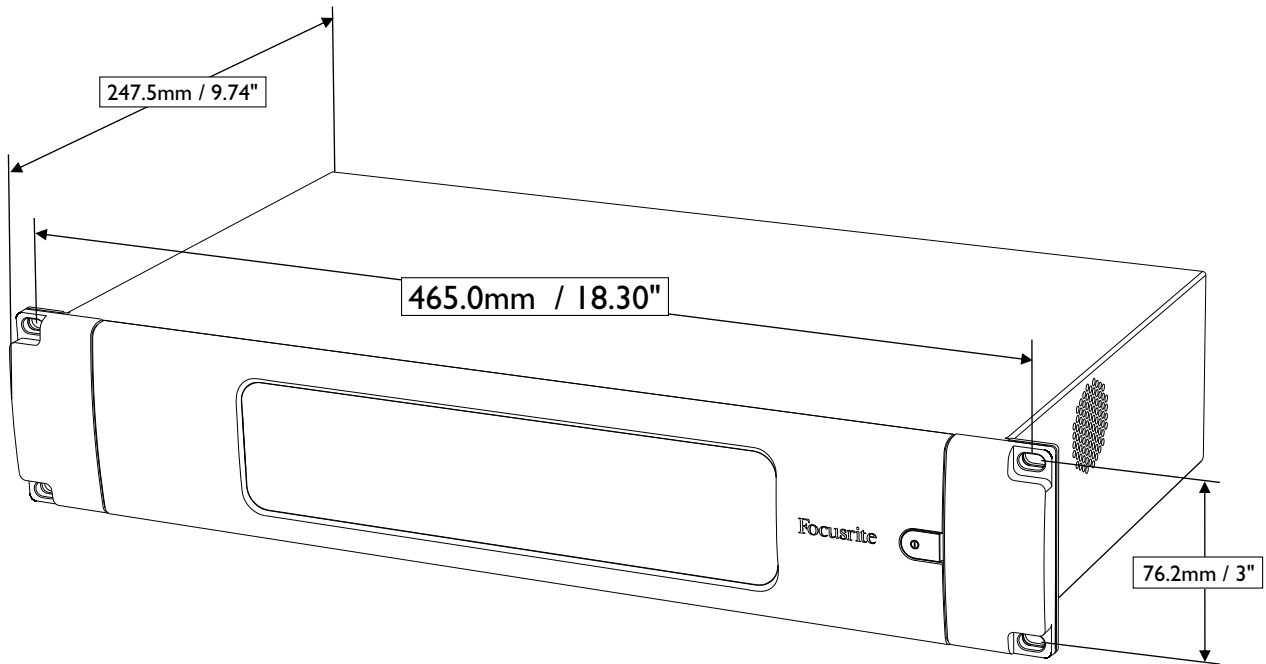

RedNet 1 requires 2U of vertical rackspace and at least 350 mm of rack depth, to allow for cables. RedNet 1 weighs 4.12 kg and for installations in a fixed environment (e.g., a studio), the front panel mounting screws will provide adequate support. If the units are to be used in a mobile situation (e.g., flight-cased for touring, etc.), consideration should be given to using side support rails within the rack.

RedNet 1 generates no significant heat, and is normally cooled by natural convection, though an internal cooling fan is fitted. We recommend that the unit should not be used in locations where the ambient temperature is greater than 30°C. However, if this is unavoidable, the fan can be turned on and off from RedNet Control.

Ventilation is via slots in the enclosure at both sides. Do not mount RedNet 1 immediately above any other equipment which generates significant heat, for example, a power amplifier. Also, ensure that when mounted in a rack, the side vents are not obstructed.

Power requirements

RedNet 1 is mains-powered. It incorporates a 'Universal' power supply, which can operate on any AC mains voltage from 100 V to 240 V. The AC connection is made via a standard 3-pin IEC connector on the rear panel. A mating IEC cable is supplied with the unit, which should be terminated with a mains plug of the correct type for your country.

The AC power consumption of the RedNet 1 is 30 VA.



Please note that there are no fuses in RedNet 1, or other user-replaceable components of any type. Please refer all servicing issues to the Customer Support Team (see "Customer Support and Unit Servicing" on page 14).

OTHER REDNET SYSTEM COMPONENTS

The RedNet hardware range includes various types of I/O interface and a PCIe digital audio interface card which is installed in the system's host computer. All the I/O units can be considered as "Break-Out" (and/or "Break-In") boxes to/from the network, and all are built in mains-powered, 2U 19" rackmounting housings. There are also three software items, RedNet Control (see below), Dante Controller and Dante Virtual Soundcard.

USING REDNET CONTROL

A virtual depiction of RedNet 1 will appear on-screen in RedNet Control when a unit is included in the active system.



Metering: Each input and output has 3 virtual LEDs corresponding to the levels indicated by the tricolour LEDs on the physical front panel. These illuminate at -42 dBFS, -6 dBFS and 0 dBFS respectively.

Tools menu : four options are offered:

- **Level Ref +24 dBu** – sets internal analogue reference level for 0 dBFS to +24 dBu
- **Level Ref +18 dBu** – sets internal analogue reference level for 0 dBFS to +18 dBu

The corresponding front panel LEDs illuminate to confirm the reference level.

- **Preferred Master** - allows the user to set the unit to be the system master clock source
- **Cooling Fan** – turns the cooling fan on and off.

APPENDIX

Connector pinouts

8-channel analogue input and output connectors

Connector type: 25-pin female Dsub
Applies to: ANALOGUE INPUTS 1-8
ANALOGUE OUTPUTS 1-8

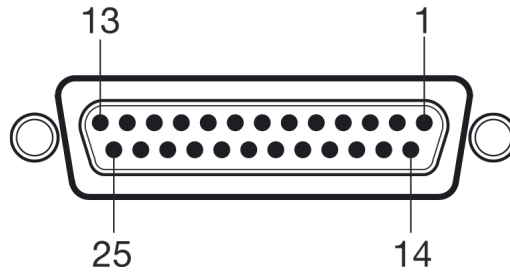

Pin	Signal		Pin	Signal
1	Ch 8 'hot' (+)		14	Ch 8 'cold' (-)
2	Ch 8 screen		15	Ch 7 'hot' (+)
3	Ch 7 cold (-)		16	Ch 7 screen
4	Ch 6 'hot' (+)		17	Ch 6 'cold' (-)
5	Ch 6 screen		18	Ch 5 'hot' (+)
6	Ch 5 cold (-)		19	Ch 5 screen
7	Ch 4 'hot' (+)		20	Ch 4 'cold' (-)
8	Ch 4 screen		21	Ch 3 'hot' (+)
9	Ch 3 cold (-)		22	Ch 3 screen
10	Ch 2 'hot' (+)		23	Ch 2 'cold' (-)
11	Ch 2 screen		24	Ch 1 'hot' (+)
12	Ch 1 cold (-)		25	Ch 1 screen
13	n/c			

Ethernet connector

Connector type: RJ-45 receptacle

Applies to: ETHERNET

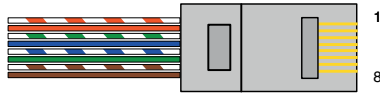

Pin	Cat6 Core
1	White + Orange
2	Orange
3	White + Green
4	Blue
5	White + Blue
6	Green
7	White + Brown
8	Brown

Performance Specifications

Inputs	
Analogue line inputs	8
Connector	25-way female Dsub, wired to AES 59
0 dBFS reference levels	+18 or +24 dBu (switchable)
Frequency response	20 Hz – 20 kHz \pm 0.05 dB
THD+N	< 0.001% unweighted; -1 dBFS input, 20 Hz – 22 kHz
Dynamic range	119 dB 'A'-weighted (-60 dBFS method)
Converter dynamic range	120 dB
Signal-to-noise ratio	119 dB 'A'-weighted; 20 Hz – 20 kHz
Outputs	
Analogue line outputs	8
Connector	25-way female Dsub, wired to AES 59
0 dBFS reference levels	+18 or +24 dBu (switchable)
Frequency response	20 Hz – 20 kHz \pm 0.15 dB
THD+N	< 0.001% unweighted; -1 dBFS input, 20 Hz – 22 kHz
Dynamic Range	119 dB 'A'-weighted (-60 dBFS method)
Converter dynamic range	120 dB
Signal-to-noise ratio	119 dB 'A'-weighted; 20 Hz – 20 kHz
Crosstalk	
Input or Output to Input	<-90 dB (all other channels at 0 dBFS)
Input or Output to Output	<-100 dB (all other channels at 0 dBFS)
Digital Performance	
Supported sample rates	44.1 / 48 / 88.2 / 96 / 192 kHz
Clock sources	Internal or from network master device
Power	
PSU	Internal, Universal type, consumption 30 VA
Front Panel Indicators	
Power	Green
Network connected	Green
Sync lock	Green
Sample rate	Yellow x 5
Input/Output range	Yellow x 2
Input/Output signal level	Bi-colour x 16 (Green = -42 dBFS; Orange = -6 dBFS; Red = overload)

Focusrite RedNet Warranty and Service

All Focusrite products are built to the highest standards and should provide reliable performance for many years, subject to reasonable care, use, transportation and storage.

Very many of the products returned under warranty are found not to exhibit any fault at all. To avoid unnecessary inconvenience to you in terms of returning the product please contact Focusrite support.

In the event of a Manufacturing Defect becoming evident in a product within 12 months from the date of the original purchase Focusrite will ensure that the product is repaired or replaced free of charge.

A Manufacturing Defect is defined as a defect in the performance of the product as described and published by Focusrite. A Manufacturing Defect does not include damage caused by post-purchase transportation, storage or careless handling, nor damage caused by misuse.

Whilst this warranty is provided by Focusrite the warranty obligations are fulfilled by the distributor responsible for the country in which you purchased the product.

In the event that you need to contact the distributor regarding a warranty issue, or an out-of-warranty chargeable repair, please visit: www.focusrite.com/distributors

The distributor will then advise you of the appropriate procedure for resolving the warranty issue. In every case it will be necessary to provide a copy of the original invoice or store receipt to the distributor. In the event that you are unable to provide proof of purchase directly then you should contact the reseller from whom you purchased the product and attempt to obtain proof of purchase from them.

Please do note that if you purchase a Focusrite product outside your country of residence or business you will not be entitled to ask your local Focusrite distributor to honour this limited warranty, although you may request an out-of-warranty chargeable repair.

This limited warranty is offered solely to products purchased from an Authorised Focusrite Reseller (defined as a reseller which has purchased the product directly from Focusrite Audio Engineering Limited in the UK, or one of its Authorised Distributors outside the UK). This Warranty is in addition to your statutory rights in the country of purchase.

Registering your product

For technical support, please register your product at: www.focusrite.com/register

Customer Support and Unit Servicing

You can contact Focusrite Customer Support at:

Email: supportteam@focusrite.com

Phone (UK): +44 (0)1494 462246

Phone (USA): +1 (310) 322-5500

Troubleshooting

If you are experiencing problems with your RedNet 1, we recommend that in the first instance, you visit our Support Answerbase at: www.focusrite.com/answerbase

