

*Suhr*<sup>®</sup>

# REACTIVE LOAD / I.R.

## User Guide



# Table of Contents

- Overview .....3
- Front panel overview .....4
- Rear panel overview .....5
- How to connect to a DAW (Digital Audio Workstation) ..... 6
- How to silently practice with headphones .....7
- Live set-up with stage volume .....8
- How to slave an amp .....9
- Impulse Response Section .....10
- Headphone Section.....11
- D.I. Section .....12
- Managing impulse responses with a computer .....13
- Impulse responses included with Reactive Load I.R. ....14
- Technical Block Diagram .....15
- Technical Specifications .....16
- Warranty .....16

**Thank you** for purchasing the Suhr Reactive Load I.R.™

Please take the time to read this User Guide to get the most out of the Reactive Load I.R. The more you familiarize yourself with the features of this unit, the more you will enjoy its benefits and maximize its potential.

## Overview

The new Reactive Load I.R. builds upon the legacy of what is already widely regarded as the industry standard for accurate speaker cabinet load replacement: the original Suhr Reactive Load. Reactive Load I.R. incorporates exciting new features into the groundbreaking design of the original Reactive Load – making it the ultimate all-in-one solution for speaker cabinet replacement.

As the name suggests, Reactive Load I.R. adds impulse response technology to the original Reactive Load, allowing you to quickly and easily access an array of expertly mic'd speaker cabinets. It comes preloaded with 16 Suhr speaker cabinet impulse responses captured by Celestion. Reactive Load I.R. is an open system, so you can load 3rd party impulse responses via the USB port.



## I.R. Select

*Turn* to select between 4 banks of 4 Impulse Responses for a total of 16 different CAB choices

*Push and hold* to 'lock' your selected I.R., this prevents accidentally changing to another I.R. even when you turn the unit on and off

## Bank Number

Displays selected Bank (1-4)

## Cab Number

Displays selected Cab I.R. (1-4)

## I.R. Lock light

Only lights up when I.R. selection is locked. (see page 10)

## Clip light

Only lights up when I.R. input signal begins clipping

## H.P. Level

*Turn* to adjust volume of IR output through headphones

## H.P. Output

*1/8" Stereo* Headphone output for easy monitoring or practice

## Aux Input

*1/8" Stereo* Auxiliary Input for connecting smart-phone or other audio device

## D.I. Level

*Turn* to control volume of Balanced/Unbalanced Outputs

## Signal Boost

Boosts signal 6db, most useful with low wattage amps

## Hi-Cut

Adjusts impedance curve, most useful when slaving an amp



## Input (From Amp)

**Plug in** 1/4" speaker cable from 8 ohms Speaker Out of amp (Generally 4 ohms is ok, but consult your amp manufacturer)

## DI/Line Out (I.R.)

**Connect 1/4" to DAW or mixer (FOH)**

This signal is filtered through the impulse response, meaning you will hear the tone with your selected I.R.

## Thru (To Speaker)

(optional)

**Connect to external speaker cabinet**

Using this option disables the internal load.

If a 1/4" cable is plugged in to this jack

**MAKE SURE the other end is plugged in to a load or damage may occur**

## DI/Line Out (Un-filtered)

**Connect 1/4" to DAW or mixer (FOH)**

This is an unfiltered (dry) signal with **NO** impulse response affecting the tone

## USB

**Connect** to computer to manage impulse responses saved on device

## Power

**Connect to 9V DC** power adapter (center negative)

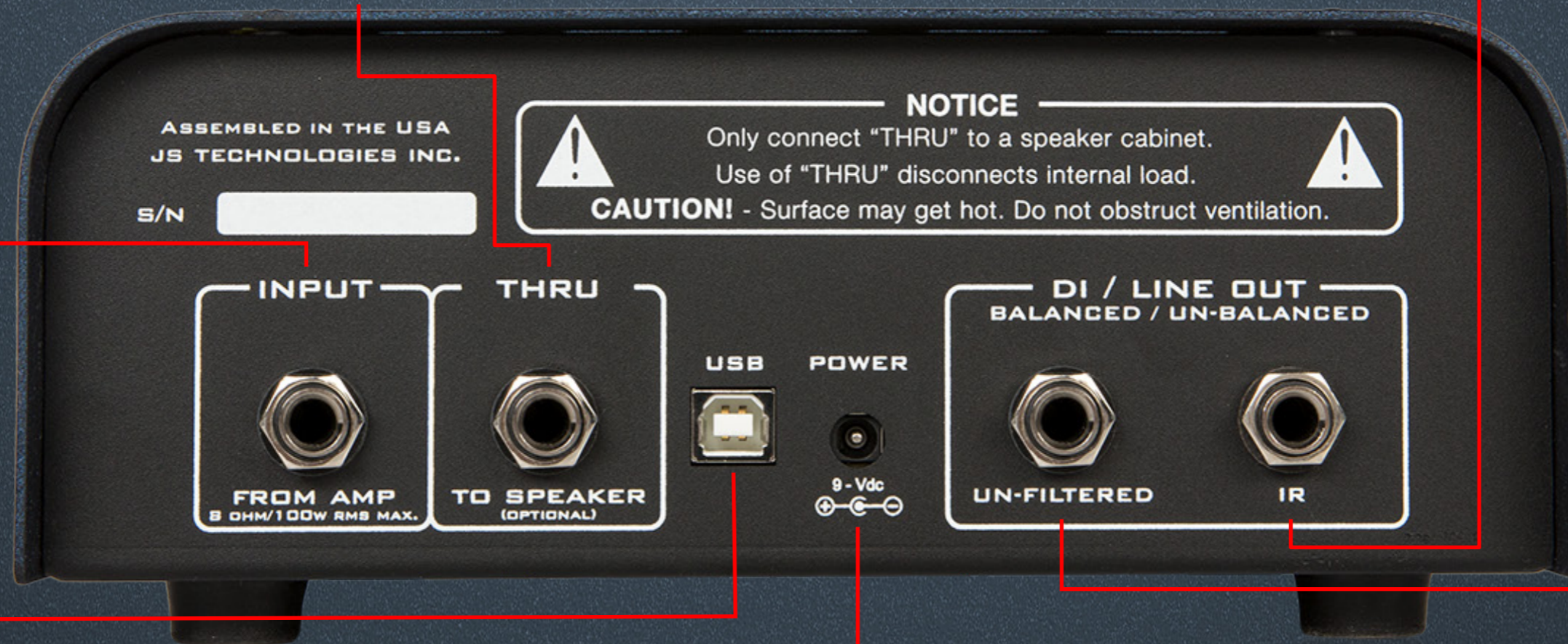

# How to connect to a DAW (Digital Audio Workstation)

This guide will show the ways you can connect your Reactive Load I.R. to a digital audio workstation.

## Steps:

1. Plug in the provided 9Vdc power adapter.
2. Connect your amplifier's **8Ω speaker out** via 1/4" speaker cable to Reactive Load I.R.'s **INPUT – FROM AMP** jack.
3. Connect the **DI / LINE OUT – IR** to record a signal that is affected by the I.R. filter.
4. Adjust **DI LEVEL** (D.I. Section in detail, page 12)
5. Turn the **IR SELECT** knob to pick an I.R.

### –Optional connections– (dotted lines on diagram)

6. Connect the **DI / LINE OUT – UN-FILTERED** to record a signal that is **NOT** affected by the I.R. filter, meaning it is just your amp's tone (with no speaker filtration), for later processing in your DAW. If you'd still like to run a speaker cabinet, connect the **THRU – TO SPEAKERS** jack using a 1/4" speaker cable to a speaker cabinet.

**IMPORTANT NOTE:** Using the **THRU – TO SPEAKERS** output disconnects the internal load of the Reactive Load I.R. To optimize performance and avoid damage, match the impedance of your amplifier to the connected speaker cabinet.  
**NEVER CONNECT THIS OUTPUT TO INSTRUMENT, MIC OR LINE LEVEL INPUTS.**

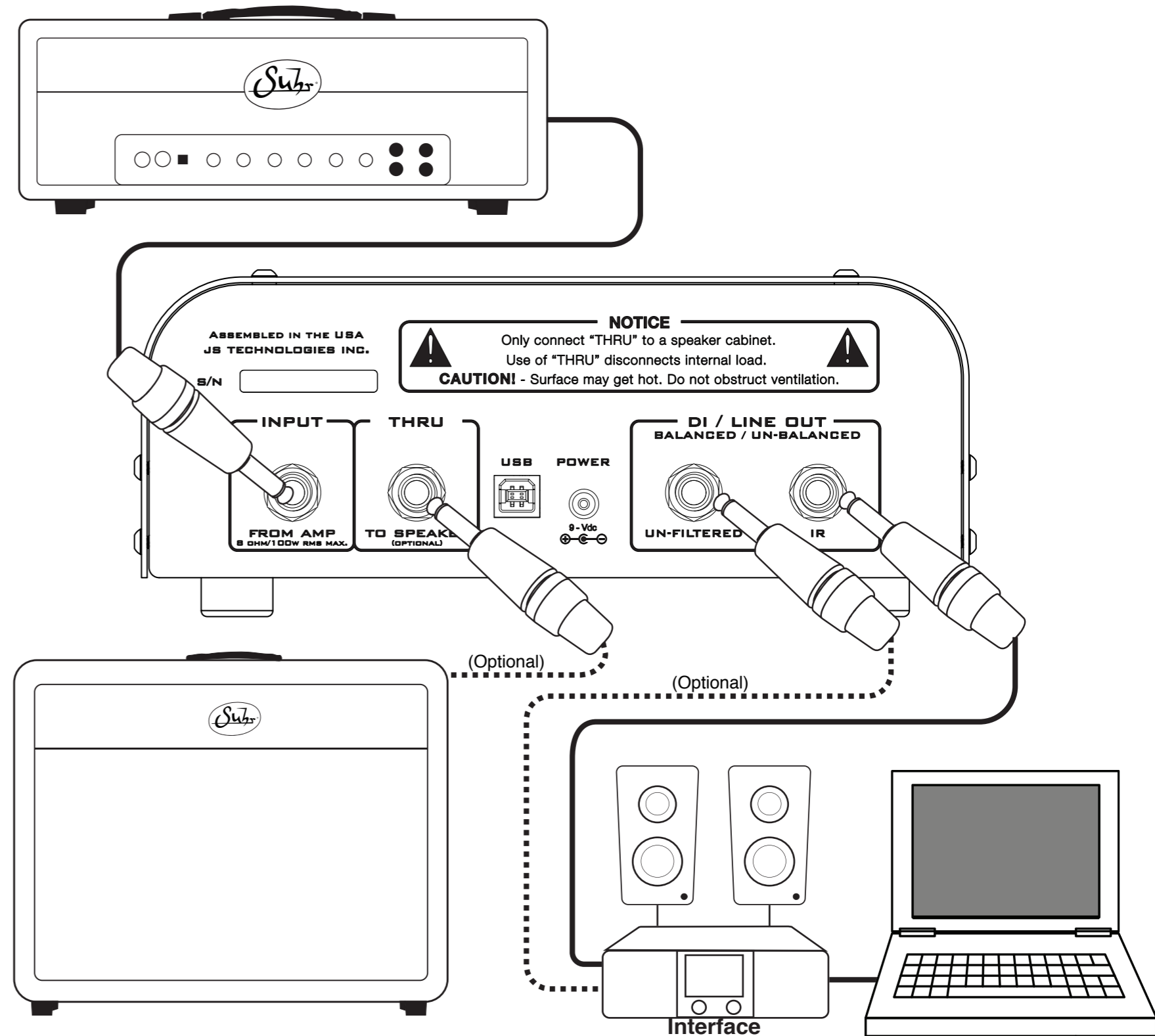

# How to silently practice with headphones

This section will explain how to use the Reactive Load I.R. to practice silently through headphones.

## Steps:

1. Plug in the provided 9Vdc power adapter.
2. Connect your amplifier's **8Ω speaker out** via 1/4" speaker cable to Reactive Load I.R.'s **INPUT – FROM AMP** jack.
3. Connect HP OUT via 1/8" stereo cable to any headphones.
4. Adjust **DI LEVEL** (D.I. Section in detail, page 12)
5. Turn the **IR SELECT** knob to pick an I.R.
6. Enjoy practicing with your favorite tube amp, quietly with headphones.

### -Optional connection- (dotted lines on diagram)

7. Connect a smart-phone or other audio source via 1/8" stereo cable

 **IMPORTANT NOTE:** The signal from the **AUX IN** will only be sent through the **HP OUT** (headphones), **NOT** the **DI / LINE OUT**.

 **HELPFUL TIP:** Use your audio source's on board volume controls to set the levels you hear through the **HP OUT**. i.e. if you need to hear more of your smart-phone, turn up the volume on the device, **NOT** the **HP LEVEL** on the Reactive Load I.R.

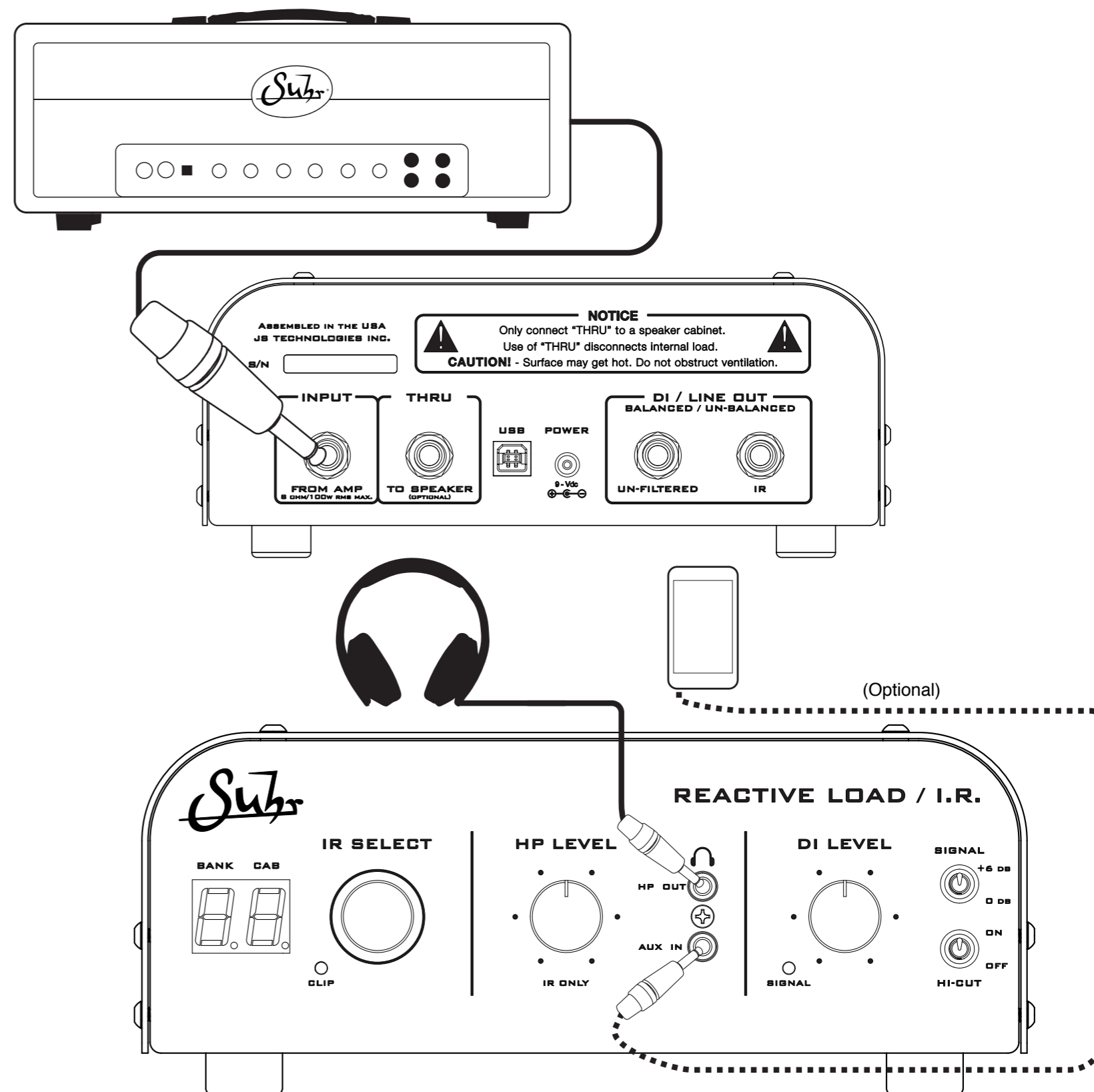

# Live set-up with stage volume

This section will explain how to use the Reactive Load I.R. in a live setting with stage volume from a cab and a D.I. signal (with an I.R.) going to front of house.

## Steps:

1. Plug in the provided 9Vdc power adapter.
2. Connect your amplifier's **8Ω speaker out** via 1/4" speaker cable to Reactive Load I.R.'s **INPUT – FROM AMP** jack.
3. Connect the **DI / LINE OUT – I.R.** jack to mixer.
4. Connect the **THRU – TO SPEAKER** jack via 1/4" speaker cable to a speaker cabinet for stage volume.
5. Adjust **DI LEVEL** (D.I. Section in detail, page 12)
6. Turn the **IR SELECT** knob to pick an I.R.
7. (Optional) **Push and Hold for 2 seconds** to "lock" your selected I.R. to keep it from changing inadvertently. (see page 10)

**IMPORTANT NOTE:** Using the **THRU – TO SPEAKERS** output disconnects the internal load of the Reactive Load I.R. To optimize performance and avoid damage, match the impedance of your amplifier to the connected speaker cabinet.  
**NEVER CONNECT THIS OUTPUT TO INSTRUMENT, MIC OR LINE LEVEL INPUTS.**

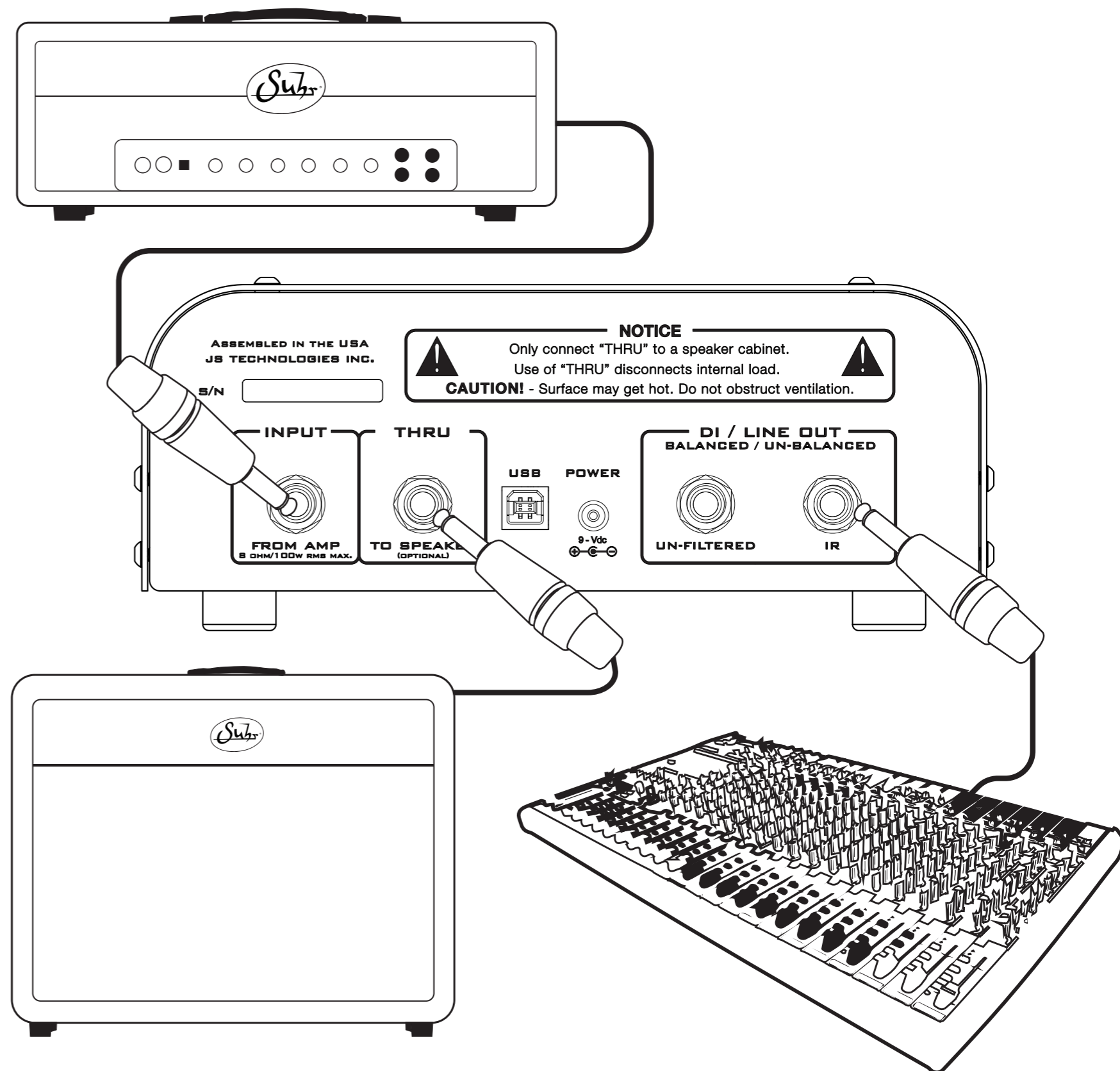



# How to slave an amp

What is slaving? Slaving is a way of controlling the volume of a high wattage, non-master volume amp. In addition, slaving can be used to add effects after the preamp section in amps that lack an effects loop. This section will explain how to crank a 100-watt amp into the Reactive Load I.R. and send it to a slave amp for volume control. This allows you to retain the power distortion of the primary amp, while using a secondary slave amp to yield lower volumes.

## Steps:

1. Plug in the provided 9Vdc power adapter.
2. Connect your primary amplifier's **8Ω speaker out** via 1/4" speaker cable to Reactive Load I.R.'s **INPUT – FROM AMP** jack.
3. Plug in the **DI / LINE OUT – UN-FILTERED** to the Effects Loop Return of the slave amp.
4. Connect the slave amplifier's **speaker out** via 1/4" speaker cable to your speaker cabinet.
5. (Optional) Use **HI-CUT**. This works by altering the impedance curve to reduce extra high-end that may occur when slaving to another amp.

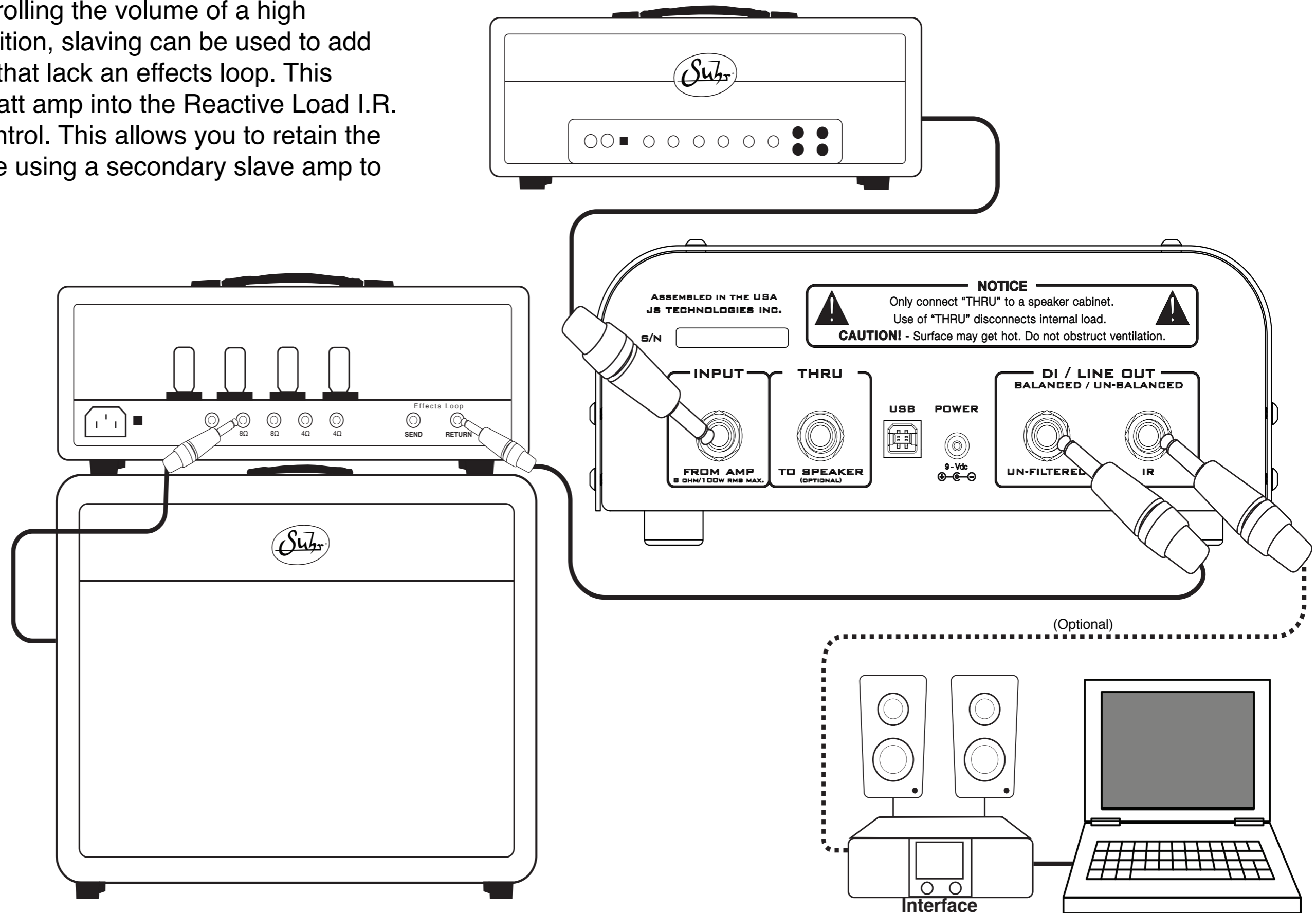

# Impulse Response Section

This section will explain in more detail the I.R. capabilities of the Reactive Load I.R.

## Things to know:

1. **Turn IR Select** knob to select between 4 banks of 4 impulse responses for a total of 16 different cab choices.
2. **Push and Hold for 2 seconds** to "lock" your selected I.R., this will freeze the number on the display, even when the unit is powered on and off, protecting you from accidentally changing I.R.s. The **LOCK INDICATOR** LED on the 7 segment display will illuminate when your I.R. selection is "locked".
3. **Push and Hold again for 2 seconds** to "unlock" and you can freely change to another I.R.
4. The **CLIP** light provides a visual representation of when excess signal is fed to the IR section, which will cause clipping of the IR output and **HP OUT**. If this occurs, reduce the signal by turning down the **DI LEVEL**.
5. To see a full list of the preloaded impulse responses see page 14.

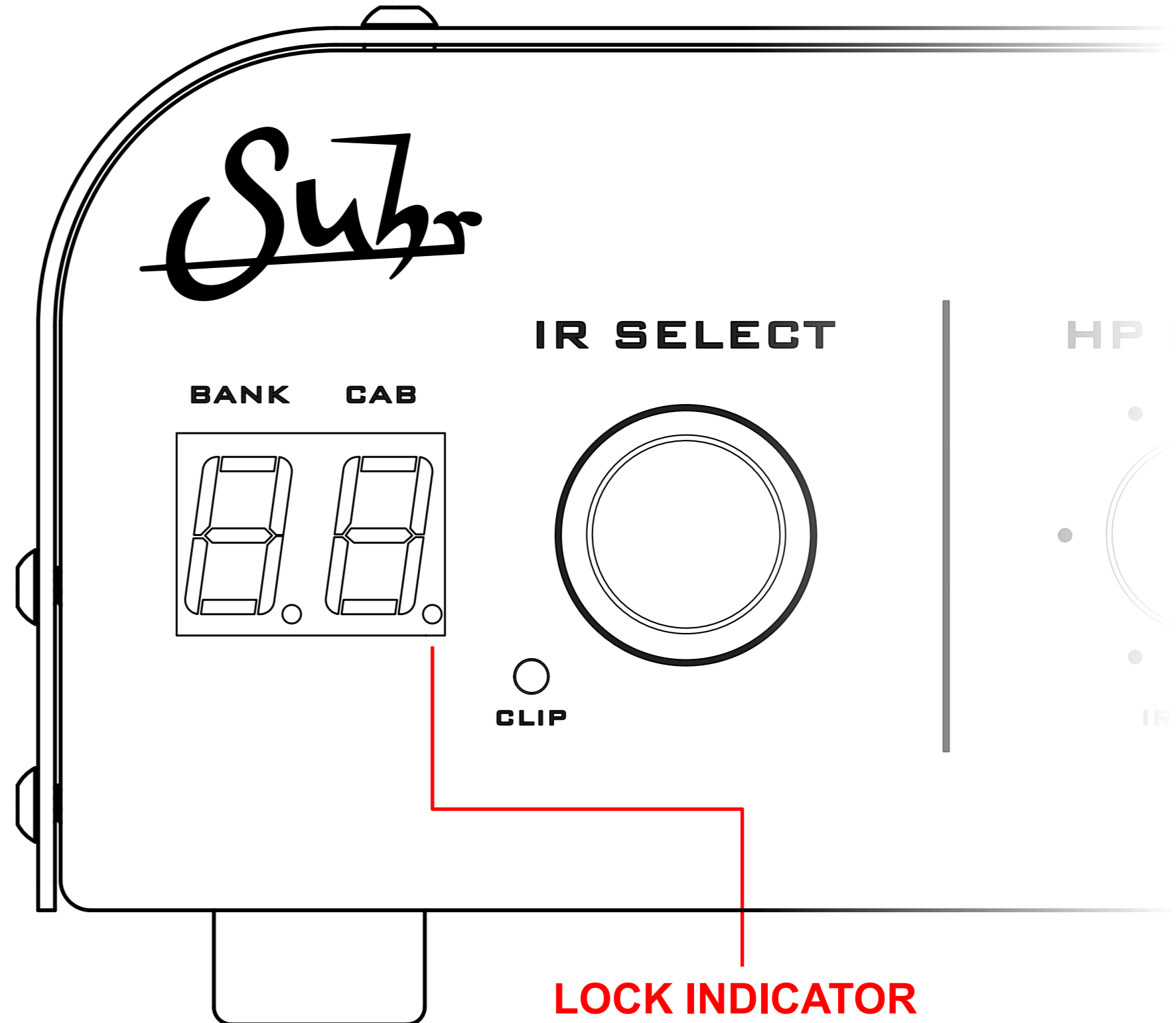

# Headphone Section

This section will explain in more detail the headphones section of the Reactive Load I.R.

## Things to know:

1. **Turn HP LEVEL** to increase the volume of the impulse response filtered signal sent to the headphone out, meaning you will only hear the signal that is affected by the impulse response chosen on the 7 segment display.
2. Connect a smart-phone or other audio source via 1/8" stereo cable
3. The signal from the **AUX IN** will only be sent through the **HP OUT** (headphones), **NOT** the **DI / LINE OUT**.
4. Use your device's on-board volume controls to set the levels you hear through the **HP OUT**, i.e. if you need to hear more of your smart-phone, turn up the volume on the device, **NOT** the **HP LEVEL** on the Reactive Load I.R.

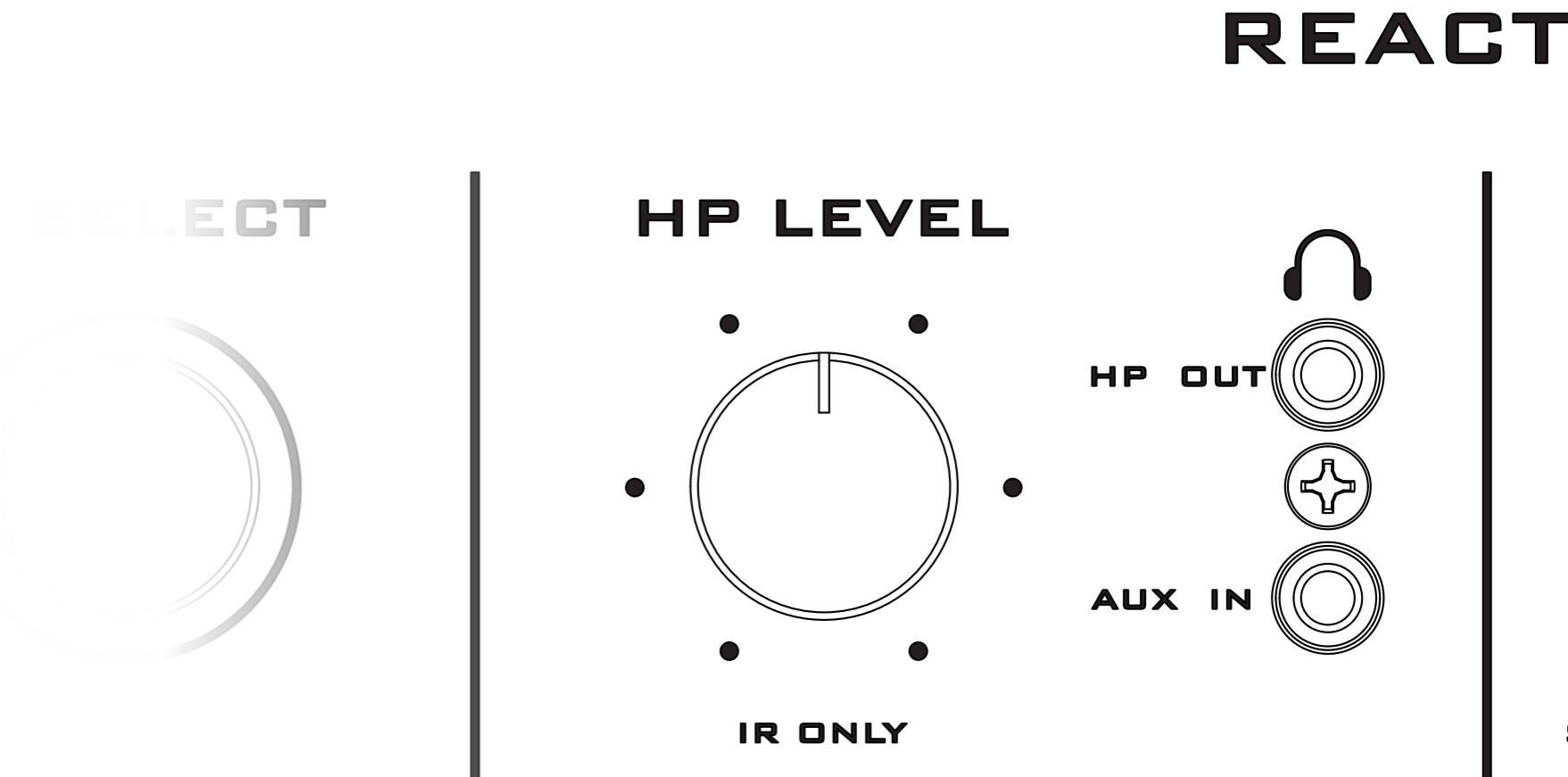

# D.I. Section

This section will explain in more detail the D.I. section of the Reactive Load I.R. The **DI LEVEL** is used to optimize the amount of signal the Reactive Load delivers to your device.

## Things to know:

1. **Adjusting DI LEVEL using CLIP light** - While using your loudest desired amp setting and performance style, turn **DI LEVEL** knob until **CLIP** light illuminates intermittently, then, back off the **DI LEVEL** knob until the **CLIP** light no longer illuminates.
2. **SIGNAL BOOST** - Increases signal by +6dB passively by altering the internal padding. This helps with low wattage amps to get a suitable level.
3. **HI-CUT** - Works by altering the impedance curve to reduce high end. This is also very useful when slaving to another amp.

**!** **IMPORTANT NOTE:** It is **NORMAL** for the Reactive Load I.R. and amplifier to make some physical noise when playing. The Reactive Load I.R. contains an internal fan which is powered by your amplifier's speaker output voltage and designed to maintain the temperature of the Reactive Load I.R.s internal components. The fan automatically turns on/off based on the amount of power delivered to the unit's Input.

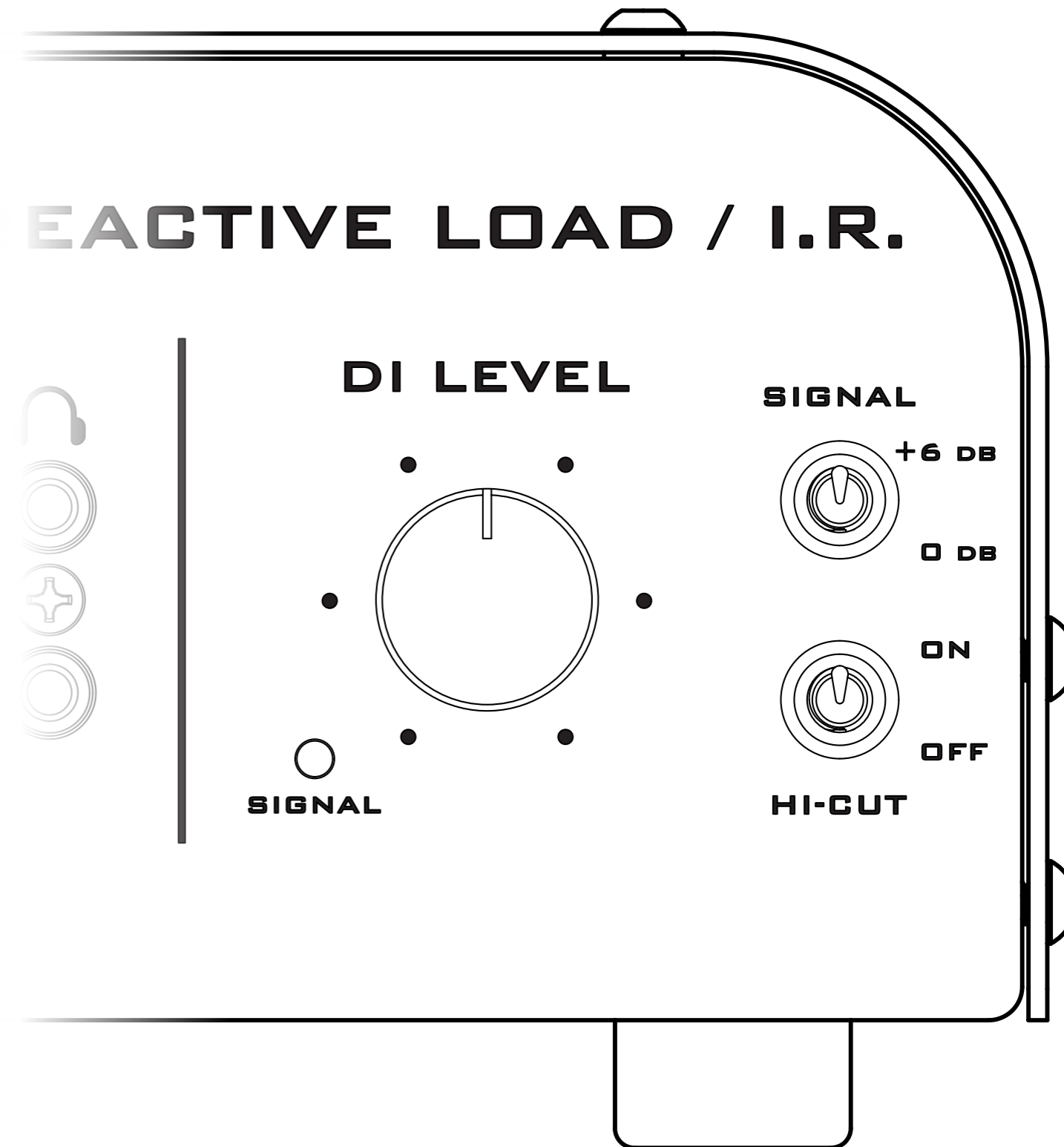

# Managing impulse responses with a computer

## Steps:

1. Plug in the provided 9Vdc power adapter
2. Connect Reactive Load I.R. to computer via USB cable
3. The *Reactive Load I.R.* will appear on your computer as "**SUHR\_RL**"
4. Click "**SUHR\_RL**" to find 4 folders named "*Bank\_1*" - "*Bank\_4*"
5. Each "*Bank\_x*" folder will contain 4 folders named "*Cabinet\_1*"-"*Cabinet\_4*"  
these are where you will find the impulse responses in the form of .WAV files.

 **IMPORTANT NOTE:** Save a backup of the original "**SUHR\_RL**" folder to a safe place on your computer in case you want to restore Reactive Load I.R. to factory settings.

 **HELPFUL TIP:** Close mic impulse responses work best. I.R.s greater than 20.5 milliseconds (ms) will be truncated to 20.5 ms.

6. After doing so, you can delete any existing I.R. (.WAV file) and simply drag and drop any 3rd party impulse response (.WAV, Mono, 24bit, 48kHz) in to its place.  
Use only one I.R. file (.WAV) per cabinet folder.

 **IMPORTANT NOTE:** After making **ANY** changes to the I.R.s loaded on the device, the unit **MUST** be power cycled in the following manner

- **Eject (unmount) "SUHR\_RL"** from your computer.
- If "SUHR\_RL" reappears on computer after ejecting, it IS safe to disconnect, as long as no files are transferring at the time.**
- **Disconnect USB** from the Reactive Load I.R. to your computer.
- **Power cycle** the Reactive Load I.R. (Unplug 9v power, wait for 3 seconds and plug back in)

7. Your Reactive Load I.R. now is filled with your own I.R.s

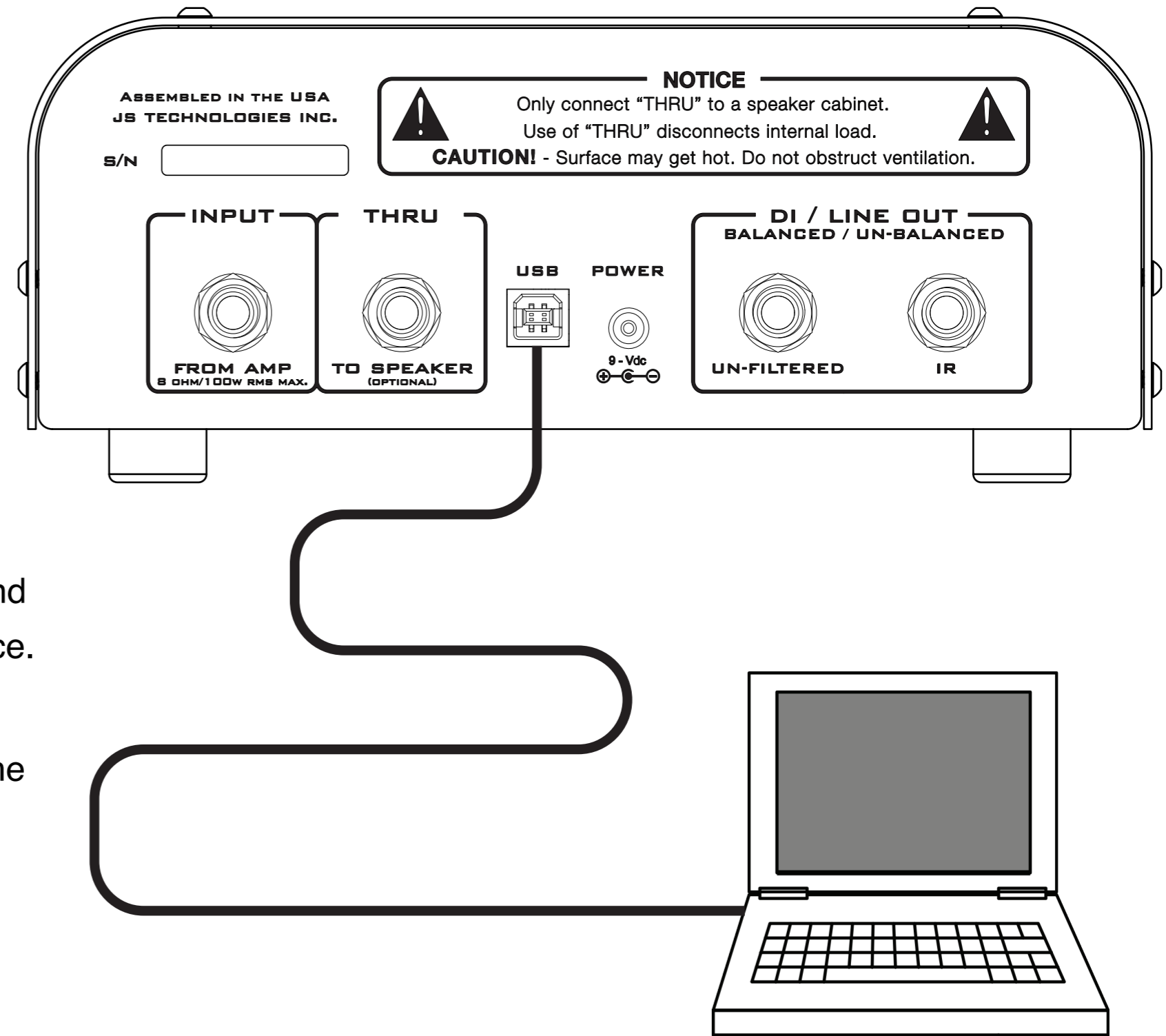

# Impulse responses included with Reactive Load I.R.

## Bank 1:

- (1.1) Cab 1 : Suhr G12M Greenback 4x12 C SM57 Balanced Celestion
- (1.2) Cab 2 : Suhr G12M Greenback 4x12 C Hi-Gn 121+57 Celestion
- (1.3) Cab 3 : Suhr G12M Greenback 4x12 C SM57 Fat Celestion
- (1.4) Cab 4 : Suhr G12M Greenback 4x12 C Lo-Gn 421+121 Celestion

## Bank 3:

- (3.1) Cab 1 : Suhr PT G12-75H Creamback 2x12 C SM57 Fat Celestion
- (3.2) Cab 2 : Suhr PT G12-75H Creamback 2x12 C Hi-Gn 121+57 Celestion
- (3.3) Cab 3 : Suhr Hedgehog G12-65 2x12 O SM57 Fat Celestion
- (3.4) Cab 4 : Suhr Hedgehog G12-65 2x12 O Hi-Gn 121+57 Celestion

## Bank 2:

- (2.1) Cab 1 : Suhr V30 4x12 C SM57 Balanced Celestion
- (2.2) Cab 2 : Suhr V30 4x12 C Hi-Gn 121+57 Celestion
- (2.3) Cab 3 : Suhr V30 4x12 C SM57 Fat Celestion
- (2.4) Cab 4 : Suhr V30 4x12 C Lo-Gn 421+121 Celestion

## Bank 4:

- (4.1) Cab 1 : Suhr Badger V30 1x12 C SM57 Balanced Celestion
- (4.2) Cab 2 : Suhr Badger V30 1x12 C Hi-Gn 121+57 Celestion
- (4.3) Cab 3 : Suhr Bella V-Type 1x12 O SM57 Dark Celestion
- (4.4) Cab 4 : Suhr Bella V-Type 1x12 O Hi-Gn 121+57 Celestion

# Technical Block Diagram

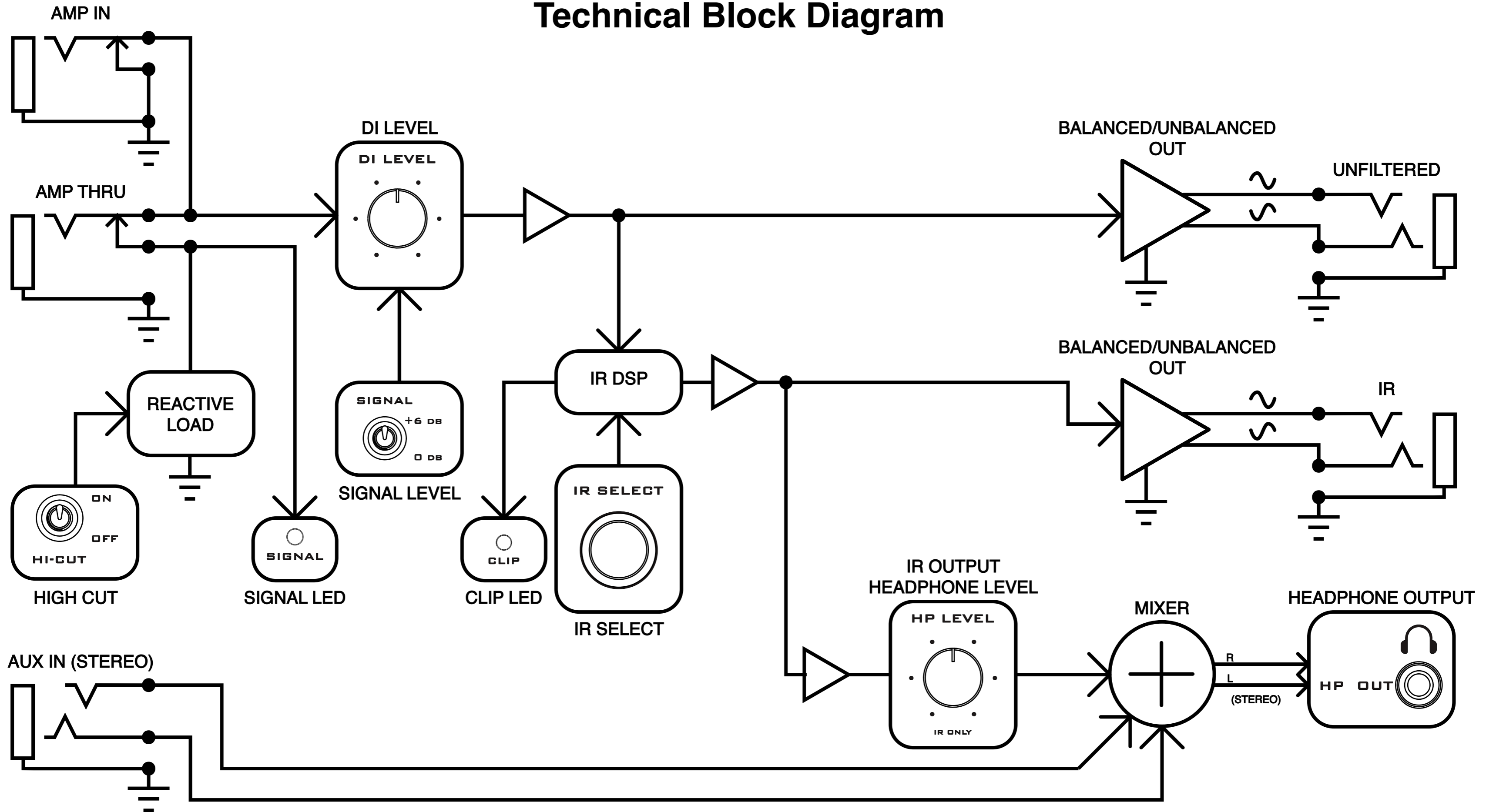

# Technical Specifications

**Impedance: 8Ω**

**Balanced Line Output Impedance: 600Ω (Maximum)**

**Unbalanced Line Output Impedance: 600Ω (Maximum)**

**Maximum recommended input power: 100 Watts RMS**

**I.R. Format: .WAV, Mono, 24bit, 48kHz, 20.5 ms  
(I.R.s greater than 20.5 ms will be truncated to 20.5 ms)**

**I.R. Output Latency: 1.2 milliseconds**

**Power Connector: 9Vdc, center negative, 2.1mm x 5.5mm**

**Operating Voltage: 9Vdc**

**Maximum Voltage: 12Vdc**

**Reverse Battery Protection: Yes**

**Over Voltage Protection: Yes**

**Current Consumption: <200mA**

**Dimensions: 8.8" Width x 8.9" Depth x 3.6" Height**

**Weight: 6.7 lbs.**

**ROHS Compliant: Yes**

**\*All specifications subject to change without prior notice**

# Warranty

JS Technologies, Inc. (JST) warrants for lifetime from date of purchase by the initial retail purchaser that this product shall be free from defects in workmanship. Electronic components such as capacitors, resistors, filters, transformers, jacks, and pots are covered for 5 years. Any parts determined defective by JST within the five (5) year term shall be repaired or replaced by JST without charge for parts and labor provided the unit is returned, transportation costs prepaid, to JS Technologies, Inc., 601 Crane Street, Unit A, Lake Elsinore, CA 92530, or to such facility authorized by JST. JST will pay shipping costs to return the unit to its owner. Defects in workmanship will be determined by JST for limited lifetime coverage.

This warranty does not cover damage caused by accident, misuse, abuse, neglect, unauthorized or improperly performed repairs, alterations, and/or wear and tear occasioned by use of the product, and does not include any expense for inconvenience or loss of use while the product is being repaired or replaced. JST expressly disclaims any liability for consequential damages arising from the sale, use, or inability to use the product. Any warranty implied by law, including any warranty of merchantability or fitness, is expressly limited to the one (5) year warranty term for the parts on our amplifiers and electronic products. The foregoing statements of warranty are exclusive and in lieu of all other remedies. Workmanship lifetime warranty is limited strictly to the original retailer purchaser of the instrument registered with JST within 10 days of purchase from an authorized JST dealer or distributor. JST will pay shipping costs to return the unit to its owner within the mainland U.S.

The above warranty policy only applies to customers in USA. If you are an international customer, please check with your distributor and the dealer in your country for warranty matters. Warranty issues must be handled through your dealer or distributor. If you are an international customer who purchased (or plan to purchase) from a US dealer, we can handle warranty matters direct but you will be responsible for shipping both ways. We encourage international customers to purchase through your local distributor or dealer for this reason. Our international distributors are set up to handle warranty issues in their respective countries. If you do not have an authorized Suhr dealer in your country, please contact us direct for further details.



**NOTE:** This equipment has been tested and found to comply with the limits for a Class B digital device, pursuant to part 15 of the FCC Rules. These limits are designed to provide reasonable protection against harmful interference in a residential installation. This equipment generates, uses and can radiate radio frequency energy and, if not installed and used in accordance with the instructions, may cause harmful interference to radio communications. However, there is no guarantee that interference will not occur in a particular installation. If this equipment does cause harmful interference to radio or television reception, which can be determined by turning the equipment off and on, the user is encouraged to try to correct the interference by one or more of the following measures: - Reorient or relocate the receiving antenna. - Increase the separation between the equipment and receiver. - Connect the equipment into an outlet on a circuit different from that to which the receiver is connected. - Consult the dealer or an experienced radio/ TV technician for help.

Changes or modifications not expressly approved by the party responsible for compliance could void the user's authority to operate the equipment.

This device complies with part 15 of the FCC Rules. Operation is subject to the following two conditions: (1) This device may not cause harmful interference, and (2) this device must accept any interference received, including interference that may cause undesired operation.