

INTEGRA-7

SuperNATURAL SOUND MODULE

Owner's Manual

Roland

Owner's Manual (this document)

Read this first. It explains the basic things you need to know in order to use the INTEGRA-7.

PDF Manual (download from the Web)

- **Parameter Guide**

This explains all parameters of the INTEGRA-7.

- **Sound List**

This is a list of the sounds built into the INTEGRA-7.

- **MIDI Implementation**

This is detailed information about MIDI messages.



To obtain the PDF manual

1. Enter the following URL in your computer.
<https://www.roland.com/manuals/>



2. Choose "INTEGRA-7" as the product name.

WARNING: To reduce the risk of fire or electric shock, do not expose this apparatus to rain or moisture.

	CAUTION RISK OF ELECTRIC SHOCK DO NOT OPEN	
ATTENTION: RISQUE DE CHOC ELECTRIQUE NE PAS OUVRIIR		
CAUTION: TO REDUCE THE RISK OF ELECTRIC SHOCK, DO NOT REMOVE COVER (OR BACK). NO USER-SERVICEABLE PARTS INSIDE. REFER SERVICING TO QUALIFIED SERVICE PERSONNEL.		



The lightning flash with arrowhead symbol, within an equilateral triangle, is intended to alert the user to the presence of uninsulated "dangerous voltage" within the product's enclosure that may be of sufficient magnitude to constitute a risk of electric shock to persons.



The exclamation point within an equilateral triangle is intended to alert the user to the presence of important operating and maintenance (servicing) instructions in the literature accompanying the product.

INSTRUCTIONS PERTAINING TO A RISK OF FIRE, ELECTRIC SHOCK, OR INJURY TO PERSONS.

IMPORTANT SAFETY INSTRUCTIONS SAVE THESE INSTRUCTIONS

WARNING - When using electric products, basic precautions should always be followed, including the following:

1. Read these instructions.
2. Keep these instructions.
3. Heed all warnings.
4. Follow all instructions.
5. Do not use this apparatus near water.
6. Clean only with a dry cloth.
7. Do not block any of the ventilation openings. Install in accordance with the manufacturers instructions.
8. Do not install near any heat sources such as radiators, heat registers, stoves, or other apparatus (including amplifiers) that produce heat.
9. Do not defeat the safety purpose of the polarized or grounding-type plug. A polarized plug has two blades with one wider than the other. A grounding type plug has two blades and a third grounding prong. The wide blade or the third prong are provided for your safety. If the provided plug does not fit into your outlet, consult an electrician for replacement of the obsolete outlet.
10. Protect the power cord from being walked on or pinched particularly at plugs, convenience receptacles, and the point where they exit from the apparatus.
11. Only use attachments/accessories specified by the manufacturer.
12. Use only with the cart, stand, tripod, bracket, or table specified by the manufacturer, or sold with the apparatus. When a cart is used, use caution when moving the cart/apparatus combination to avoid injury from tip-over.
13. Unplug this apparatus during lightning storms or when unused for long periods of time.
14. Refer all servicing to qualified service personnel. Servicing is required when the apparatus has been damaged in any way, such as power-supply cord or plug is damaged, liquid has been spilled or objects have fallen into the apparatus, the apparatus has been exposed to rain or moisture, does not operate normally, or has been dropped.



For the U.K.

WARNING: THIS APPARATUS MUST BE EARTHED

IMPORTANT: THE WIRES IN THIS MAINS LEAD ARE COLOURED IN ACCORDANCE WITH THE FOLLOWING CODE.
GREEN-AND-YELLOW: EARTH, BLUE: NEUTRAL, BROWN: LIVE

As the colours of the wires in the mains lead of this apparatus may not correspond with the coloured markings identifying the terminals in your plug, proceed as follows:

The wire which is coloured GREEN-AND-YELLOW must be connected to the terminal in the plug which is marked by the letter E or by the safety earth symbol  or coloured GREEN or GREEN-AND-YELLOW.

The wire which is coloured BLUE must be connected to the terminal which is marked with the letter N or coloured BLACK.

The wire which is coloured BROWN must be connected to the terminal which is marked with the letter L or coloured RED.

USING THE UNIT SAFELY



Before using this unit, carefully read the sections entitled: "IMPORTANT SAFETY INSTRUCTIONS" (p. 2), "USING THE UNIT SAFELY" (p. 3), and "IMPORTANT NOTES" (p. 5). These sections provide important information concerning the proper operation of the unit. Additionally, in order to feel assured that you have gained a good grasp of every feature provided by your new unit, Owner's manual should be read in its entirety. The manual should be saved and kept on hand as a convenient reference.

Copyright © 2012 ROLAND CORPORATION



All rights reserved. No part of this publication may be reproduced in any form without the written permission of ROLAND CORPORATION.

INSTRUCTIONS FOR THE PREVENTION OF FIRE, ELECTRIC SHOCK, OR INJURY TO PERSONS

About ⚠ WARNING and ⚠ CAUTION Notices

 WARNING	Used for instructions intended to alert the user to the risk of death or severe injury should the unit be used improperly.
 CAUTION	Used for instructions intended to alert the user to the risk of injury or material damage should the unit be used improperly. * Material damage refers to damage or other adverse effects caused with respect to the home and all its furnishings, as well to domestic animals or pets.

About the Symbols

	The ⚠ symbol alerts the user to important instructions or warnings. The specific meaning of the symbol is determined by the design contained within the triangle. In the case of the symbol at left, it is used for general cautions, warnings, or alerts to danger.
	The ⓧ symbol alerts the user to items that must never be carried out (are forbidden). The specific thing that must not be done is indicated by the design contained within the circle. In the case of the symbol at left, it means that the unit must never be disassembled.
	The ● symbol alerts the user to things that must be carried out. The specific thing that must be done is indicated by the design contained within the circle. In the case of the symbol at left, it means that the power-cord plug must be unplugged from the outlet.

ALWAYS OBSERVE THE FOLLOWING

⚠ WARNING

Make sure that the power cord is grounded

Connect mains plug of this model to a mains socket outlet with a protective earthing connection.



Do not disassemble or modify by yourself

Do not open or perform any internal modifications on the unit.



Do not repair or replace parts by yourself

Do not attempt to repair the unit, or replace parts within it (except when this manual provides specific instructions directing you to do so). Refer all servicing to your retailer, the nearest Roland Service Center, or an authorized Roland distributor, as listed on the "Information" page.



⚠ WARNING

Do not use or store in the following types of locations

- Subject to temperature extremes (e.g., direct sunlight in an enclosed vehicle, near a heating duct, on top of heat-generating equipment); or are
- Damp (e.g., baths, washrooms, on wet floors); or are
- Exposed to steam or smoke; or are
- Subject to salt exposure; or are
- Humid; or are
- Exposed to rain; or are
- Dusty or sandy; or are
- Subject to high levels of vibration and shakiness.



Do not place in an unstable location

When using the unit with a rack or stand recommended by Roland, the rack or stand must be carefully placed so it is level and sure to remain stable. If not using a rack or stand, you still need to make sure that any location you choose for placing the unit provides a level surface that will properly support the unit, and keep it from wobbling.



Connect the power cord to an outlet of the correct voltage

The unit should be connected to a power supply only of the type described as marked on the rear side of unit.



⚠ WARNING

Use only the included power cord

Use only the attached power-supply cord. Also, the included power cord must not be used with any other device.



Do not bend the power cord or place heavy objects on it

Do not excessively twist or bend the power cord, nor place heavy objects on it. Doing so can damage the cord, producing severed elements and short circuits. Damaged cords are fire and shock hazards!



Avoid extended use at high volume

This unit, either alone or in combination with an amplifier and headphones or speakers, may be capable of producing sound levels that could cause permanent hearing loss. Do not operate for a long period of time at a high volume level, or at a level that is uncomfortable. If you experience any hearing loss or ringing in the ears, you should immediately stop using the unit, and consult an audiologist.



Don't allow foreign objects or liquids to enter unit; never place containers with liquid on unit

Do not place containers containing liquid on this product. Never allow foreign objects (e.g., flammable objects, coins, wires) or liquids (e.g., water or juice) to enter this product. Doing so may cause short circuits, faulty operation, or other malfunctions.



WARNING

Turn off the unit if an abnormality or malfunction occurs

- Immediately turn the unit off, remove the power cord from the outlet, and request servicing by your retailer, the nearest Roland Service Center, or an authorized Roland distributor, as listed on the “Information” page when: 
- The power-supply cord or the plug has been damaged; or
- If smoke or unusual odor occurs; or
- Objects have fallen into, or liquid has been spilled onto the unit; or
- The unit has been exposed to rain (or otherwise has become wet); or
- The unit does not appear to operate normally or exhibits a marked change in performance.

Adults must provide supervision in places where children are present

When using the unit in locations where children are present, be careful so no mishandling of the unit can take place. An adult should always be on hand to provide supervision and guidance. 

Do not drop or subject to strong impact

Protect the unit from strong impact. (Do not drop it!) 

Do not share an outlet with an unreasonable number of other devices

Do not force the unit’s power-supply cord to share an outlet with an unreasonable number of other devices. Be especially careful when using extension cords—the total power used by all devices you have connected to the extension cord’s outlet must never exceed the power rating (watts/amperes) for the extension cord. Excessive loads can cause the insulation on the cord to heat up and eventually melt through. 

Do not use overseas

Before using the unit in a foreign country, consult with your retailer, the nearest Roland Service Center, or an authorized Roland distributor, as listed on the “Information” page. 

Don’t place burning objects on the unit

Don’t place any burning object (such as a candle) on the unit. 

Be aware of weather conditions

Use the apparatus in moderate climates. 

CAUTION

Place in a well ventilated location

The unit should be located so that its location or position does not interfere with its proper ventilation. 

Grasp the plug when connecting or disconnecting the power cord

Always grasp only the plug on the power-supply cord when plugging into, or unplugging from, an outlet or this unit. 

Periodically clean the power cord’s plug

At regular intervals, you should unplug the power plug and clean it by using a dry cloth to wipe all dust and other accumulations away from its prongs. Also, disconnect the power plug from the power outlet whenever the unit is to remain unused for an extended period of time. Any accumulation of dust between the power plug and the power outlet can result in poor insulation and lead to fire. 

Manage cables for safety

Try to prevent cords and cables from becoming entangled. Also, all cords and cables should be placed so they are out of the reach of children. 

Avoid climbing on top of the unit, or placing heavy objects on it

Never climb on top of, nor place heavy objects on the unit. 

Do not connect or disconnect the power cord with wet hands

Never handle the power cord or its plugs with wet hands when plugging into, or unplugging from, an outlet or this unit. 

Disconnect everything before moving the unit

Before moving the unit, disconnect the power plug from the outlet, and pull out all cords from external devices. 

Unplug the power cord from the outlet before cleaning

Before cleaning the unit, turn it off and unplug the power cord from the outlet (p. 22). 

If there is a possibility of lightning strike, disconnect the power cord from the outlet

Whenever you suspect the possibility of lightning in your area, pull the plug on the power cord out of the outlet. 

IMPORTANT NOTES

Power Supply

- Do not connect this unit to same electrical outlet that is being used by an electrical appliance that is controlled by an inverter or a motor (such as a refrigerator, washing machine, microwave oven, or air conditioner). Depending on the way in which the electrical appliance is used, power supply noise may cause this unit to malfunction or may produce audible noise. If it is not practical to use a separate electrical outlet, connect a power supply noise filter between this unit and the electrical outlet.
- To prevent malfunction and equipment failure, always make sure to turn off the power on all your equipment before you make any connections.
- Although the LCD and LEDs are switched off when the unit is turned off, this does not mean that the unit has been completely disconnected from the source of power. If you need to turn off the power completely, first turn off the unit's switch, then unplug the power cord from the power outlet. For this reason, the outlet into which you choose to connect the power cord's plug should be one that is within easy reach and readily accessible.
- With the factory settings, the INTEGRA-7 will automatically be switched off four hours after you stop playing or operating the unit. If you don't want the unit to turn off automatically, change the "Auto Off" setting to "OFF" as described on p. 55.
- * The settings you were editing will be lost when the unit is turned off. If you want to keep your settings, you must save your settings before turning the unit off.

Placement

- Using the unit near power amplifiers (or other equipment containing large power transformers) may induce hum. To alleviate the problem, change the orientation of this unit; or move it farther away from the source of interference.
- This device may interfere with radio and television reception. Do not use this device in the vicinity of such receivers.
- Noise may be produced if wireless communications devices, such as cell phones, are operated in the vicinity of this unit. Such noise could occur when receiving or initiating a call, or while conversing. Should you experience such problems, you should relocate such wireless devices so they are at a greater distance from this unit, or switch them off.
- When moved from one location to another where the temperature and/or humidity is very different, water droplets (condensation) may form inside the unit. Damage or malfunction may result if you attempt to use the unit in this condition. Therefore, before using the unit, you must allow it to stand for several hours, until the condensation has completely evaporated.

- Depending on the material and temperature of the surface on which you place the unit, its rubber feet may discolor or mar the surface. You can place a piece of felt or cloth under the rubber feet to prevent this from happening. If you do so, please make sure that the unit will not slip or move accidentally.
- Do not put anything that contains water on this unit. Also, avoid the use of insecticides, perfumes, alcohol, nail polish, spray cans, etc., near the unit. Swiftly wipe away any liquid that spills on the unit using a dry, soft cloth.

Maintenance

- For everyday cleaning wipe the unit with a soft, dry cloth or one that has been slightly dampened with water. To remove stubborn dirt, use a cloth impregnated with a mild, non-abrasive detergent. Afterwards, be sure to wipe the unit thoroughly with a soft, dry cloth.
- Never use benzene, thinners, alcohol or solvents of any kind, to avoid the possibility of discoloration and/or deformation.

Repairs and Data

- Please be aware that all data contained in the unit's memory may be lost when the unit is sent for repairs. Important data should always be backed up USB flash drives, or written down on paper (when possible). During repairs, due care is taken to avoid the loss of data. However, in certain cases (such as when circuitry related to memory itself is out of order), we regret that it may not be possible to restore the data, and Roland assumes no liability concerning such loss of data.

Additional Precautions

- Please be aware that the contents of memory can be irretrievably lost as a result of a malfunction, or the improper operation of the unit. To protect yourself against the risk of losing important data, we recommend that you periodically save a backup copy of important data you have stored in the unit's memory on a USB flash drives.
- Unfortunately, it may be impossible to restore the contents of data that was stored in the unit's memory, USB flash drives once it has been lost. Roland Corporation assumes no liability concerning such loss of data.
- Use a reasonable amount of care when using the unit's buttons, sliders, or other controls; and when using its jacks and connectors. Rough handling can lead to malfunctions.
- Never strike or apply strong pressure to the display.
- When disconnecting all cables, grasp the connector itself—never pull on the cable. This way you will avoid causing shorts, or damage to the cable's internal elements.
- A small amount of heat will radiate from the unit during normal operation.

- To avoid disturbing others nearby, try to keep the unit's volume at reasonable levels. You may prefer to use headphones, so you do not need to be concerned about those around you.
- When you need to transport the unit, package it in the box (including padding) that it came in, if possible. Otherwise, you will need to use equivalent packaging materials.

Before Using External Memories

Using External Memories

- Carefully insert the USB flash drives all the way in—until it is firmly in place.

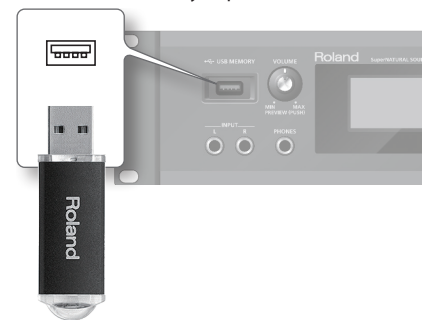

- Never touch the terminals of the USB flash drives. Also, avoid getting the terminals dirty.
- USB flash drives are constructed using precision components; handle the USB flash drives carefully, paying particular note to the following.
 - To prevent damage to the cards from static electricity, be sure to discharge any static electricity from your own body before handling the USB flash drives.
 - Do not touch or allow metal to come into contact with the contact portion of the USB flash drives.
 - Do not bend, drop, or subject USB flash drives to strong shock or vibration.
 - Do not keep USB flash drives in direct sunlight, in closed vehicles, or other such locations.
 - Do not allow USB flash drives to become wet.
 - Do not disassemble or modify the USB flash drives.

Handling DVDs

- Avoid touching or scratching the shiny underside (encoded surface) of the disc. Damaged or dirty DVD discs may not be read properly. Keep your discs clean using a commercially available DVD cleaner.

Intellectual Property Right

- Do not use this product for purposes that could infringe on a copyright held by a third party. We assume no responsibility whatsoever with regard to any infringements of third-party copyrights arising through your use of this product.
- The copyright of content in this product (the sound waveform data, style data, accompaniment patterns, phrase data, audio loops and image data) is reserved by Roland Corporation.
- Purchasers of this product are permitted to utilize said content for the creating, performing, recording and distributing original musical works.
- Purchasers of this product are NOT permitted to extract said content in original or modified form, for the purpose of distributing recorded medium of said content or making them available on a computer network.
- Before you open the included DVD-ROM, you must read the "license agreement." Opening the DVD-ROM will be taken to mean your acceptance of the license agreement.
- MMP (Moore Microprocessor Portfolio) refers to a patent portfolio concerned with microprocessor architecture, which was developed by Technology Properties Limited (TPL). Roland has licensed this technology from the TPL Group.
- Microsoft product screen shot(s) reprinted with permission from Microsoft Corporation.
- This product contains eCROS integrated software platform of eSOL Co.,Ltd. eCROS is a trademark of eSOL Co., Ltd. in Japan.
- Roland, SuperNATURAL are either registered trademarks or trademarks of Roland Corporation in the United States and/or other countries.
- Cakewalk is a registered trademark of Cakewalk, Inc. in the United States.
- SONAR is a trademark of Cakewalk, Inc.
- Company names and product names appearing in this document are registered trademarks or trademarks of their respective owners.

Contents

IMPORTANT SAFETY INSTRUCTIONS	2
USING THE UNIT SAFELY	3
IMPORTANT NOTES	5

Quick Guide 8

Main Features	8
Getting Ready	10
Using the Internal Sounds	12
Using the Expansion Sounds	14
Creating a Sound Field with Depth	16
Using SONAR LE to Play Sounds (Windows)	18

Introduction 20

Panel Descriptions	20
Front Panel	20
Turning the INTEGRA-7 On/Off	21
Playing the Demo Song	21
Rear Panel Connections	22
Getting Acquainted with the INTEGRA-7	24
Studio Sets	24
How a Tone Is Structured	24
How a Studio Set Is Structured	25
Effects	26
About Memory	27

Basic Operation	28
Switching Parts	28
Moving the Cursor	28
Editing a Value	28
[SHIFT] Button Operations	29
[ENTER] Button Operations	29
Saving	29
Assigning a Name	29
Inserting or Deleting Characters	29

Playing/Creating Sounds 30

Playing Sounds	30
Choosing a Studio Set	30
Viewing a List of All Parts (PART VIEW -ALL- Screen)	30
Viewing the Part Settings (PART VIEW Screen)	30
Temporarily Silencing a Part's Sound (MUTE)	30
Listening to Only One Part (SOLO)	30
Choosing a Tone	31
Selecting Tones from a Tone List by Category	31
Selecting Tones from a Tone List by Type/Bank	31
Selecting Drum Kits from a Tone List	31

Editing a Studio Set	32
Studio Set Common Settings	32
Editing the Part Settings	32
Saving a Studio Set	34
Panning the Sound with Depth (MOTIONAL SURROUND Screen)	34
Editing the Motional Surround Settings	35
Turning Effects On/Off	35
Editing the Effects of a Studio Set (EFFECTS ROUTING Screen)	36
Editing the CHORUS Settings	36
Editing the REVERB Settings	36
Adjusting the Overall Tone of the Audio Output (MASTER EQ)	36
Initializing a Part	37
Initializing the Sound Controls	37
Initializing a Studio Set	37

Editing a Tone	38
Editing the Tones Assigned to a Part	38
SuperNATURAL Acoustic Tone (SN-A)	38
SuperNATURAL Synth Tone (SN-S)	38

SuperNATURAL Drum Kit (SN-D)	39
PCM Synth Tone (PCMS)	39
PCM Drum Kit (PCMD)	40
Saving a Tone/Drum Kit	40
Editing the Effects of a Tone	41
Editing the MFX (Multi-Effect) Settings	41
Editing the COMP (Compressor) and EQ (Equalizer) Settings	41
Initializing a Tone	42
Initializing a Partial	42
Copying a Partial	42
Selecting the Partial to Edit	42

Use with a Computer 43

Using the INTEGRA-7 with Your Computer	43
USB Driver	44
Connecting the INTEGRA-7 to Your Computer	44
USB MIDI	45
MIDI Signal Flow	45
Specifying the Output Destination of the Incoming Messages	45
USB AUDIO	46
Audio Signal Flow	46
Specifying the Sampling Rate for USB Audio	46

Applying Motional Surround to Sounds of an External Device	47
Connection Example	47

Overall Settings 48

Overall Settings	48
System Settings	48
Saving the System Settings	48
System Parameter	48
Viewing the System Version	49

Convenient Functions	50
Basic Procedure for Utility Operations	50
Initializing a USB Flash Drive (FORMAT USB MEMORY)	50
Exporting/Importing Sound Data	51
Exporting Sound Data (Export)	51
Importing Sound Data (Import)	51
Marking Multiple Items of Data	52
Deleting an Exported File	52
Renaming an Exported File	52
Backing Up User Data	52
Backing Up to a USB Flash Drive (BACKUP)	52
Restoring Backed-up Settings from a USB Flash Drive (RESTORE)	53
Deleting a Backup File	53
Renaming a Backup File	53
Backing Up USB Flash Drive Data to a Computer	53
Restoring Backed-up Data from a Computer to a USB Flash Drive	54
Transmitting the Temporary Area's Data to an External MIDI Device (BULK DUMP)	54
Restoring the Factory Settings (FACTORY RESET)	55
Making the Unit Automatically Turn Off After a Time (Auto Off)	55

Appendix 56

Troubleshooting	56
Error Message List	58
MIDI Implementation Chart	59
Specifications	60
Index	61
Block Diagram	62

01 Main Features

The INTEGRA-7 is a completely new sound module that contains expressive and high-quality **SuperNATURAL sounds** in addition to a rich sound library from the ever-popular **SRX series**, as well as **“Motional Surround,”** which uses RSS (Roland Sound Space) technology to offer a new type of sound field.

The powerful SuperNATURAL sounds are reproduced using Motional Surround in a deeper and even more natural sound field, allowing a truly new dimension of sound creation.

SuperNATURAL tones provide not only realistic sound, but also rich, natural expression during a performance

SuperNATURAL Acoustic Tones

The SuperNATURAL acoustic tones built into the INTEGRA-7 do not merely reproduce the sound of acoustic instruments, they also use Behavior Modeling Technology to simulate the characteristic behavior of an instrument when it is played.

A dedicated sound engine tuned specifically for each type of instrument analyzes the phrases performed by the player, automatically differentiating between chordal and melodic playing to produce the optimal expression for a performance.

For example, the “violin” SuperNATURAL acoustic tone allows your conventional keyboard playing to create a realistically expressive solo violin sound that sounds as if it were being played by a violinist.

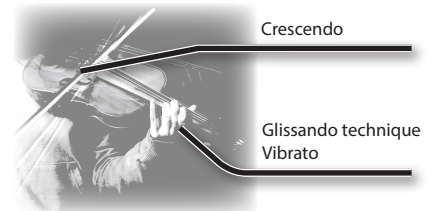

SuperNATURAL Synth Tones

These are SuperNATURAL synth tones, which realistically reproduce sounds ranging from vintage analog synths to digital synths. Each synth tone consists of three sets of OSC, FILTER, AMP, and LFO, meaning that powerful synth sounds can be created using just a single synth tone.

In addition, the behaviors of the oscillators and filters of analog synths have been analyzed, allowing their distinctive sounds to be reproduced. The INTEGRA-7 contains more than 1,000 sounds, which cover every type of synth sound from analog to digital.

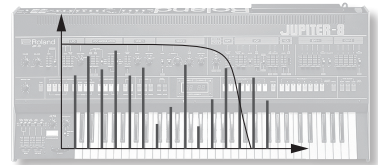

SuperNATURAL Drum Kits

The SuperNATURAL drum kits built into the INTEGRA-7 provide not only realistic, high-quality sound, they also boast smooth tonal change in response to your playing dynamics or to repeated strikes.

For example, the crash cymbal can be played not only by a powerful strike, but will also respond to a light touch. The ride cymbal will shift through a variety of tones in response to your varying dynamics. The drum will also respond appropriately to repeated strikes, so press rolls, flams, and fill-ins will sound natural.

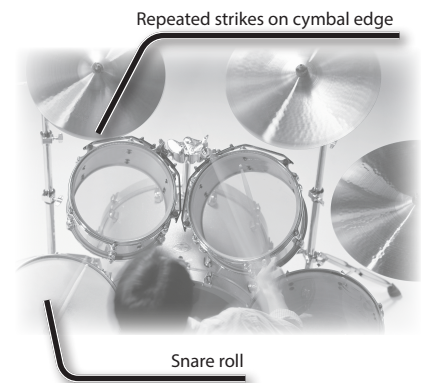

What is SuperNATURAL?

These are proprietary Roland sounds created using Behavior Modeling Technology, which enables natural and rich expression that was difficult to achieve on earlier sound generators.



What is Behavior Modeling Technology?

Not only physical modeling of the instruments, Roland takes it a step further by modeling the instrument's distinctive behavior that responds to how the performer plays, resulting in true-to-life, expressive sounds in realtime.

The INTEGRA-7 brings together the classic sounds of Roland synthesizers (PCM Tones)

Classic preset sounds from past models of Roland synthesizers, as well as the sounds from the entire SRX series wave expansion boards have been included, especially tuned for the INTEGRA-7.

The sound data includes PCM synth tones and PCM drum kits, and can be called up from the preset banks and expansion banks.

The sounds of the SRX series are organized into SRX-01 through SRX-12 just as on the actual SRX models; when you load an entire title of sound data into one of the four virtual slots, those sounds will be available for use.

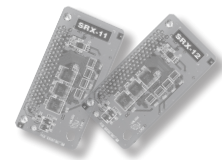

PCM Synth Tones

These are sounds that were called "patches" on previous Roland synthesizers; they have been tuned specifically for the INTEGRA-7. One PCM synth tone can consist of up to four partials (waves).

PCM Drum Kits

These were called "rhythm sets" on previous Roland synthesizers; they have been tuned specifically for the INTEGRA-7. A drum kit is a group of multiple percussion instrument sounds assigned so that a different percussion instrument will be heard depending on the key (note number) you play.

Multi-effects Usable for 16 Parts Simultaneously

All of the tones (SuperNATURAL tones and PCM tones) built into the INTEGRA-7 includes dedicated multi-effect settings. Since a multi-effect can be used by each of the 16 parts simultaneously, the most appropriate multi-effect settings will be called up when you select a tone.

Motional Surround lets you control not only left/right panning but also depth

The INTEGRA-7 supports two-channel output as well as 5.1 channel surround. Using the Motional Surround function gives you even more freedom to manipulate the spatial position of each part (p. 16).

Until now, sounds in a MIDI sound module could only be panned between left and right. However, the INTEGRA-7 lets you specify the depth as well, allowing you to create a sound field that has unprecedented depth and spaciousness.

For example, a solo instrument can be placed nearby, while the ensemble or percussion instruments are placed at a distance, thus creating a sound field with greater depth; or you can create a perceptual space that extends beyond the actual speakers.

This effect can be applied to external input signals as well, so you can use it on audio tracks as well as on the sounds of the sound module.

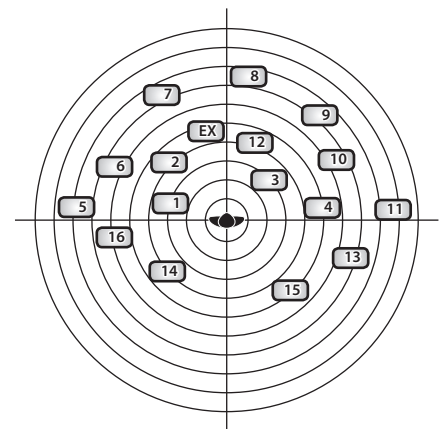

* To use the Motional Surround function, turn the [MOTIONAL SURROUND] button ON (p. 16, p. 34).

What is Motional Surround?

In the sounds we hear every day, the "direct sound," which reaches our ears directly from the sound source, is combined with the "reflected sound," which has bounced off various objects in the environment. The combination of these two types of sound gives us a sense of the distance between us and the sound source. Motional Surround takes into account the state of the actual room, and simulates the way in which objects in the room reflect the sound, thus creating a three-dimensional sound field.

In order to create the most realistic sound field, the INTEGRA-7 contains a processor that generates a sense of distance, reverberation, and directionality, and also performs format conversion.

As appropriate for your playback system, Motional Surround supports both 5.1 channel and two-channel output.

02 Getting Ready

Connection example 1: A compact production setup

Here's an example of the use of the INTEGRA-7 for high-quality music production.

This is an easy way to set up a full-fledged music production system based on the INTEGRA-7 simply by connecting it to DAW software in your computer and to a MIDI keyboard.

* If you turn the INTEGRA-7's USB-MIDI Thru setting "ON," you'll be able to use it as a MIDI interface (p. 45).

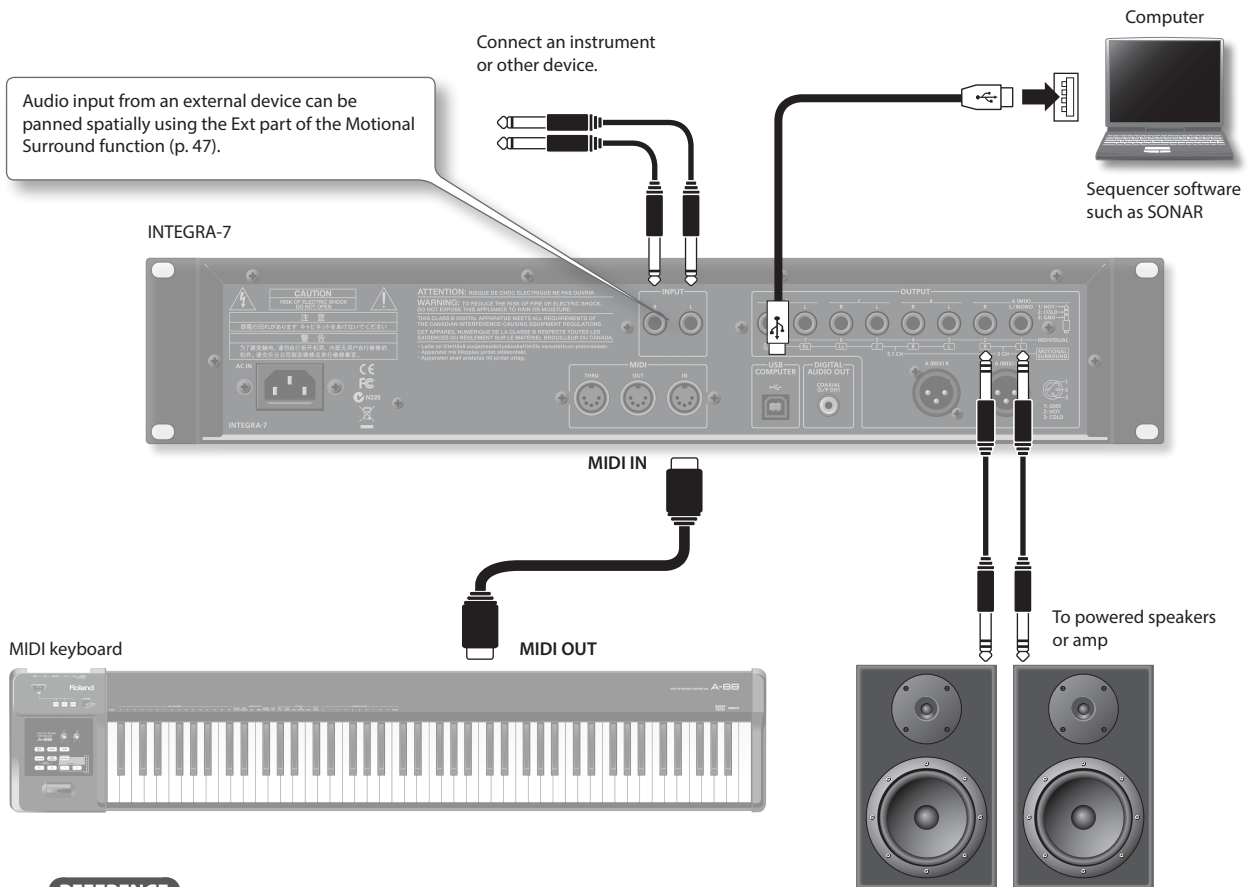

REFERENCE

For details on connections, refer to "Rear Panel Connections" (p. 22).

Connecting your computer via USB

If you connect the INTEGRA-7 to your computer using a USB cable, you'll be able to use your DAW software to record performance data (MIDI data) from a MIDI keyboard connected to the INTEGRA-7, and use performance data (MIDI data) played back by the DAW software to play the sound generator of the INTEGRA-7 (USB MIDI).

The INTEGRA-7 will operate as a MIDI sound module when it is connected to your computer with a USB cable.

"USB MIDI" page 45

To use USB audio functionality

You'll need to install a driver in order to use the USB audio functionality of the INTEGRA-7. This driver can be downloaded from the Roland website.

Roland website

<https://www.roland.com/global/support/>

For the installation procedure, refer to the Readme file that was extracted along with the installer.

You need to set the "Ext Part Source Select" parameter under "Volume and Pitch Settings (SOUND)" (p. 48) to "USB AUDIO."

"USB AUDIO" page 46

Connection example 2: Using the INTEGRA-7 as a sound module for live performance

Here's a connection example of including the INTEGRA-7 in an existing live performance system.

In this example, the MIDI connector is used to connect a keyboard or another sound module.

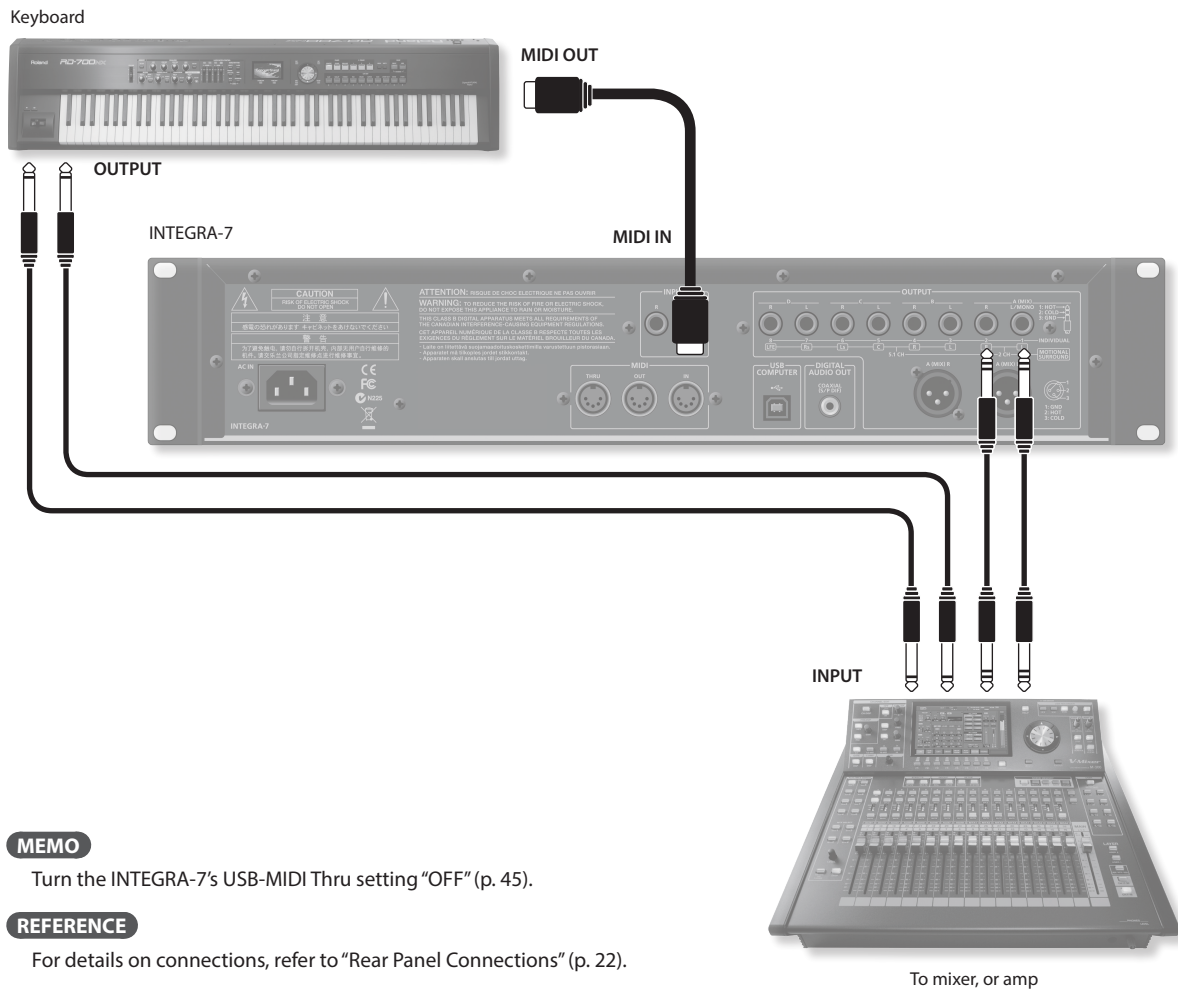

MEMO

Turn the INTEGRA-7's USB-MIDI Thru setting "OFF" (p. 45).

REFERENCE

For details on connections, refer to "Rear Panel Connections" (p. 22).

About MIDI

MIDI (Musical Instrument Digital Interface) is a standard specification that allows musical data to be transferred between electronic musical instruments and computers. If a MIDI cable is connected between devices equipped with MIDI connectors, you'll be able to play multiple devices from a single MIDI keyboard, perform ensembles using multiple MIDI instruments, program the settings to change automatically as the song progresses, and more.

03 Using the Internal Sounds

About the INTEGRA-7's screen

When you turn on the INTEGRA-7, the top screen will appear. You can choose the type of top screen (p. 48).

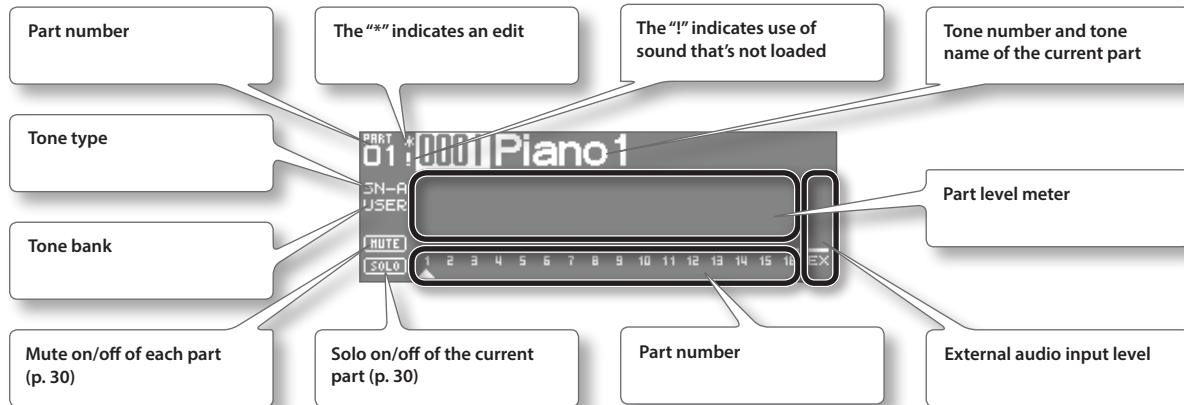

Playing SuperNATURAL tones

1. Press the [SuperNATURAL] button.



The tone of the selected part will change to a SuperNATURAL tone.

The display will show the SuperNATURAL tone list.

2. Use the cursor buttons to change the type or the bank.
3. Use the value dial to select a tone.
4. Press the [ENTER] button.

The part's tone will be selected.

MEMO

Tone Preview function

By pressing the [VOLUME] knob you can audition the tone of the selected part.

Playing PCM tones

1. Press the [PCM] button.



The tone of the selected part will change to a PCM tone.
The display will show the PCM tone list.

2. Use the cursor buttons to change the type or the bank.
 3. Use the value dial to select a tone.
 4. Press the [ENTER] button.
- The part's tone will be selected.

Connecting a MIDI keyboard and performing

Connection example

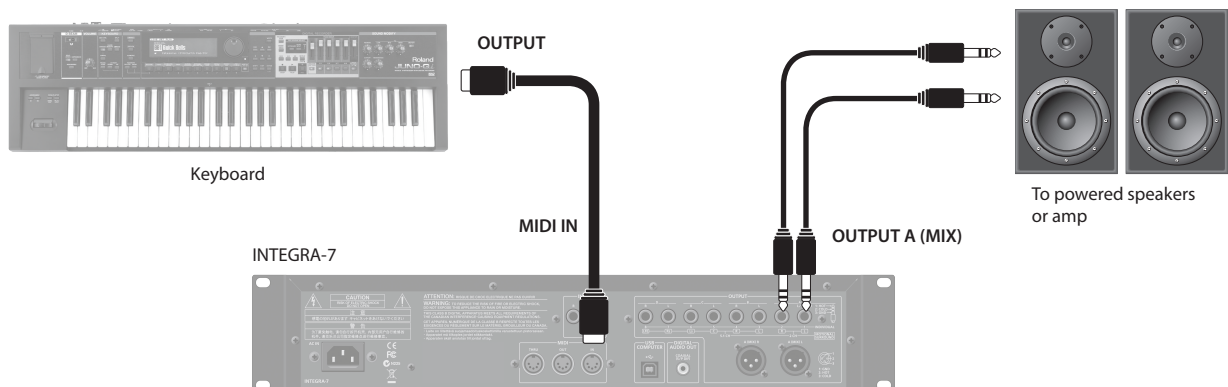

* Depending on the settings of the connected MIDI keyboard, note messages played on the keyboard might be transmitted on several channels. Make settings on your MIDI keyboard so that the MIDI output is appropriate.

Types and Features of the Internal Sounds

For details on how to select sounds, refer to p. 12.

SuperNATURAL Acoustic Tone (SN-A)

Changes in dynamics

From delicate pianissimo to powerful fortissimo, these tones provide natural timbral variation (dynamics) that goes beyond mere changes in volume.

* Dynamics can be controlled by note-on velocity, modulation controller (CC01), and expression (CC11).

While a note is sounding, you can operate the modulation controller (CC01) or expression pedal (CC11) to continuously control the dynamics (except for struck-string instruments and plucked-string instruments).

Legato

By playing legato (the technique of sending the next note-on before releasing the previous key) you can produce smooth transitions between notes.

* To obtain the legato effect, set the Mono/Poly of the part settings to "MONO" and set the Legato switch to "ON" (p. 32).

Switching variation sounds

Each instrument provides effective performance variation sounds; you can use control changes CC80, CC81, CC82, CC83 (Tone Variation 1–4) to switch instantly between them as you play.

SuperNATURAL Synth Tone (SN-S)

Realistic filter behavior

The INTEGRA-7 contains filters that simulate the classic analog synths of the past, producing natural-sounding change when you vary the cutoff frequency (CC74) or resonance (CC71).

SuperNATURAL Drum Kit (SN-D)

Changes in dynamics

From delicate pianissimo to powerful fortissimo, these sounds provide natural timbral variation (dynamics) that goes beyond mere changes in volume.

Eliminates boring uniformity even for repeated attacks

To avoid monotonous uniformity, the sense of attack will differ for each strike.

Ambience control for the entire kit

The drum kit consists of multiple drum instruments such as snare, kick, and hi-hat. You can control the resonance between instruments and the ambience of the room.

PCM Synth Tone (PCMS) / PCM Drum Kit (PCMD)

The PCM synth tones and PCM drum kits are what were called patches and rhythm sets on previous Roland synthesizers; they are remarkable for their high quality and their rich variations. Many classic sounds tuned specifically for the INTEGRA-7 are included.

04 Using the Expansion Sounds

About the EXPANSION Virtual Slots

The INTEGRA-7 contains all the sound data from the entire SRX series of wave expansion boards, as well as expansion SuperNATURAL tones.

You can add these sounds by loading each title into one of the INTEGRA-7's four EXPANSION Virtual Slots (Slot A–D). (In other words, sound data for up to four titles can be used simultaneously.)

The sound data includes tones (patches), drum kits (rhythm sets), instruments, and wave (waveform) data. (The content will vary by title.)

Sound data (expansion)

The INTEGRA-7 contains all SRX series sound data, expansion SuperNATURAL tones, and high-quality GM2 sounds.

SRX series (all 12 titles)

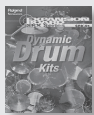

SRX-01

Dynamic Drum Kits
PCM Synth Tone : 41
PCM Drum Kit : 79



SRX-02

Concert Piano
PCM Synth Tone : 50



SRX-03

Studio SRX
PCM Synth Tone : 128
PCM Drum Kit : 12



SRX-04

Symphonique Strings
PCM Synth Tone : 128



SRX-05

Supreme Dance
PCM Synth Tone : 312
PCM Drum Kit : 34



SRX-06

Complete Orchestra
PCM Synth Tone : 449
PCM Drum Kit : 5



SRX-07

Ultimate Keys
PCM Synth Tone : 475
PCM Drum Kit : 11



SRX-08

Platinum Trax
PCM Synth Tone : 448
PCM Drum Kit : 21



SRX-09

World Collection
PCM Synth Tone : 414
PCM Drum Kit : 12



SRX-10

Big Brass Ensemble
PCM Synth Tone : 100



SRX-11

Complete Piano
PCM Synth Tone : 42



SRX-12

Classic EPs
PCM Synth Tone : 50

Expansion SuperNATURAL sounds

- ExSN1** Ethnic (SuperNATURAL Acoustic Tone : 17)
Ethnic instruments such as kalimba and santur
- ExSN2** Wood Winds (SuperNATURAL Acoustic Tone : 17)
Woodwinds such as sax and flute
- ExSN3** Session (SuperNATURAL Acoustic Tone : 50)
Electric guitar and bass
- ExSN4** A. Guitar (SuperNATURAL Acoustic Tone : 12)
Acoustic guitar
- ExSN5** Brass (SuperNATURAL Acoustic Tone : 12)
Brass instruments such as trumpet and trombone
- ExSN6** SFX (SuperNATURAL Drum Kit : 7)
Realistic sound effects

High-quality GM2 sounds/Diverse synth sounds

- ExPCM** HQ GM2 + HQ PCM Sound Collection
High-quality GM2 sounds and a variety of synth sounds
- HQ GM2 (GM2#)
PCM Synth Tone : 256
PCM Drum Kit : 9
- HQ PCM (ExPCM)
PCM Synth Tone : 512
PCM Drum Kit : 19
- * ExPCM uses all four slots.

EXPANSION Virtual Slots

Choose one title of sound data for each slot.

Slot A

Slot B

Slot C

Slot D

Sound banks (example)

PRESET

USER

SRX-01

ExSN3

SRX-11

SRX-05

When you load expansion sound data into the EXPANSION Virtual Slots (A–D), the loaded sounds will be available for selection from the corresponding sound bank (title is displayed).

Loading sound data into an EXPANSION Virtual Slot

1. Press the [MENU] button.
2. Choose "EXPANSION" and press the [ENTER] button.
The EXPANSION screen will appear. This screen shows the sounds that are loaded into each EXPANSION Virtual Slot.
3. In the VIRTUAL SLOTS area, move the cursor to the slot that you want to load, and use the [DEC] [INC] buttons to select the desired sound data.

MEMO

To view the expansion sound list, move the cursor to "INFO/LIST" and press the [ENTER] button.

4. Move the cursor to "LOAD" and press the [ENTER] button.

A message will ask "Are you sure?"

5. To execute, choose "OK" and press the [ENTER] button.

MEMO

You can also access the EXPANSION (VIRTUAL SLOT) screen by holding down the [SHIFT] button and pressing the [MENU] button.



Sound data to be loaded
An "*" symbol is shown at the left of the name of edited sound data.

Using SRX series sounds

SRX series sounds can be selected in the same way as PCM sounds.

Select one SRX bank (SRX-01–SRX-12) to use the sounds that have been loaded into an EXPANSION Virtual Slot.

* Some SRX titles have no PCM drum kit (PCMD).

Using SuperNATURAL sounds

SuperNATURAL sounds that have been loaded can be selected in the same way as the SuperNATURAL sounds of preset memory or user memory.

Select one ExSN bank (ExSN1–ExSN6) to use the sounds that have been loaded into an EXPANSION Virtual Slot.

* ExSN 1–5 contain only SuperNATURAL acoustic tones, and ExSN6 contains only SuperNATURAL drum kits.

Using ExPCM sounds

Loaded ExPCM sounds can be selected in the same way as PCM sounds.

The sounds loaded into the EXPANSION Virtual Slot can be made available for use by selecting the ExPCM bank.

When you load the ExPCM sounds, the "GM2" bank indication will change to "GM2#", and high-quality GM2 sounds will be available.

* The ExPCM sounds use all four slots.

* You can't edit ExPCM tones.

If you want the expansion sounds to be loaded automatically at start-up

You can have the INTEGRA-7 automatically load specified sound data into the EXPANSION Virtual Slots upon startup.

* With the factory settings, the sound data will be loaded.

1. Press the [MENU] button.
2. In the MENU screen, choose "SYSTEM" and press the [ENTER] button.
3. Select the desired sound data for Startup Exp Slot A–D.
4. Hold down the [SHIFT] button and press the [EDIT] button to save the settings.

05 Creating a Sound Field with Depth

Connection example

Here's an example of using the INTEGRA-7's Motional Surround function for 5.1 channel surround output.

Place your speakers as shown in the illustration.

To use the Motional Surround function, press the [MOTIONAL SURROUND] button to turn the Motional Surround function on.

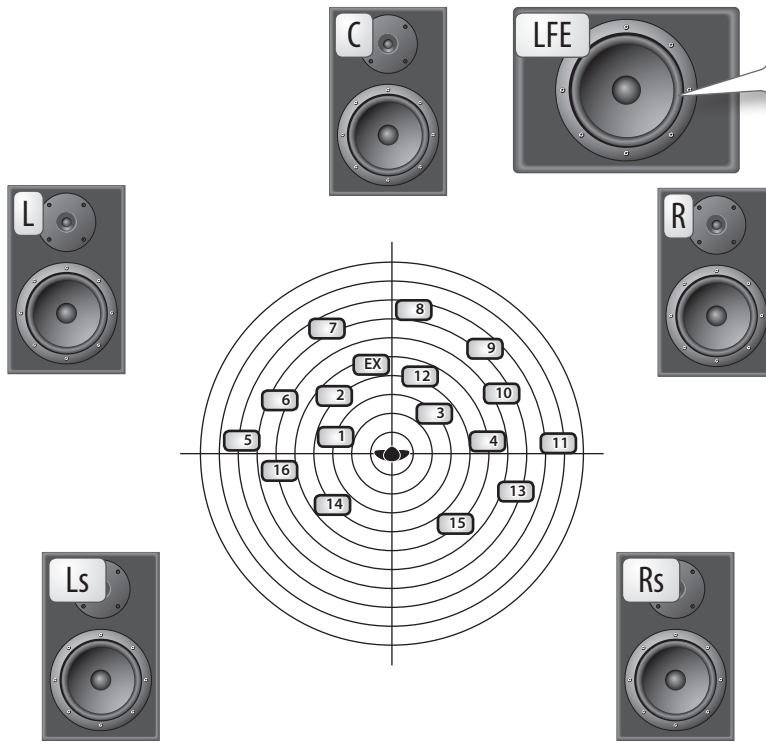

It's best to place the subwoofer at the same distance as the satellite speakers, with the listening position at the center.

Jack name	Explanation
L	Front left output
R	Front right output
C	Front center output
Ls	Rear left output
Rs	Rear right output
LFE	Subwoofer output

* Dolby Digital and DTS are not supported. Please use analog cables to connect five speakers and a subwoofer.

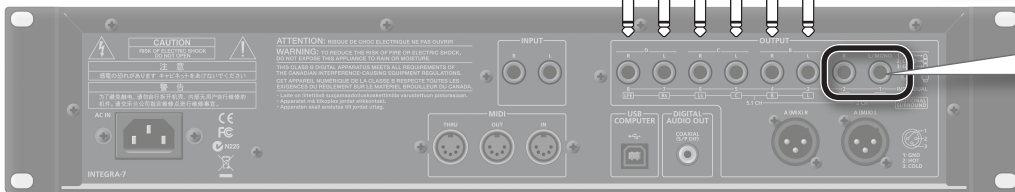

If you want to use Motional Surround with a two-channel system, connect your speakers to the A (MIX) L (MONO)/R jacks.

REFERENCE

- For more about connections, refer to "Rear Panel Connections" (p. 22).
- For more about front center speaker (C jack) and subwoofer (LFE jack) output settings, refer to "Motional Surround Settings (MOTIONAL SURROUND)" (p. 49) in System Settings.

About the monitoring environment

- An acoustically dead space with minimal reverberation is ideal as a monitoring room.
- You should monitor at the sweet spot of your speaker system.

Concerning perception of a sound image's location

- The ease with which one can sense where a sound emanates from can differ depending on the sound. For example, it is difficult to perceive the spatial location of low-frequency sounds or sounds that have relatively little harmonic content (such as sine waves). Conversely, it tends to be easier to determine the location of sounds having rich harmonic content and a distinct attack.
- Perception of front/back localization can differ between individuals.

Using Motional Surround

1. Press the [MOTIONAL SURROUND] button.

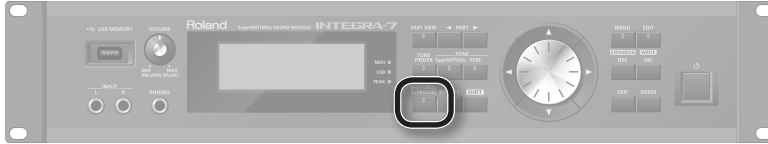

Motional Surround will turn on, and the MOTIONAL SURROUND screen will appear.



2. Use the PART [◀] [▶] buttons to select a part.

The selected part number will be highlighted.

3. Use the cursor buttons to specify the sound's panning (front/rear, left/right).

Detailed settings for Motional Surround

Here's how to make detailed settings for the ambience effect and for each part.

1. In the MOTIONAL SURROUND screen, press the [ENTER] button.

The MOTIONAL SURROUND EDIT screen will appear.

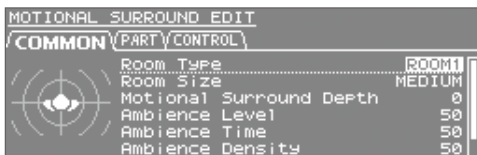

2. Use the cursor [◀] [▶] buttons to select the "COMMON," "PART," or "CONTROL" tab, and use the cursor [▲] [▼] buttons to select a parameter.
3. Use the value dial to edit the setting.

REFERENCE

For details on the each parameters, refer to p. 35.

What is Motional Surround?

The INTEGRA-7 supports two-channel and 5.1 channel surround output. By using the Motional Surround function, you can freely and easily control the placement of each part (p. 34).

While conventional systems allow sound to be placed only in the left/right direction, this new function adds the front/back dimension, enabling you to play sounds that you've freely placed in a soundscape with depth. Additionally, you can specify the type and size of room; this allows you to adjust the acoustics as appropriate for your song, ranging from an intimate room to a large concert hall.

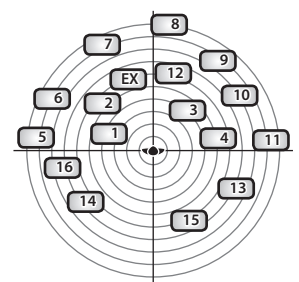

06 Using SONAR LE to Play Sounds (Windows)

Installing SONAR LE

Install the included SONAR LE in your computer.

For details on installation and main operations, refer to the manual included on the SONAR LE DVD-ROM.

* SONAR LE is for Windows only. If you are a Mac user, you'll need to obtain DAW software separately.

Audio and MIDI settings

Important!

Before you begin making settings, download the INTEGRA-7's USB driver from the Roland website and install it (p. 43). When installing the driver, change the USB Driver setting to "VENDER" (p. 44).

Audio settings

Specify the INTEGRA-7 as the audio input and output.

1. Use a USB cable to connect the INTEGRA-7 to your computer.
Connect the INTEGRA-7 to your computer as shown in "Connection example 1: A compact production setup" (p. 10).
2. Start up SONAR.
3. The "Quick Start" dialog box will appear. Click [Close].
4. Click [Edit] → [Preferences] to access the "Preferences" dialog box.
5. From the "Audio" list at the left of the screen, choose [Options]. Choose "ASIO" as the driver mode, and click [Apply].

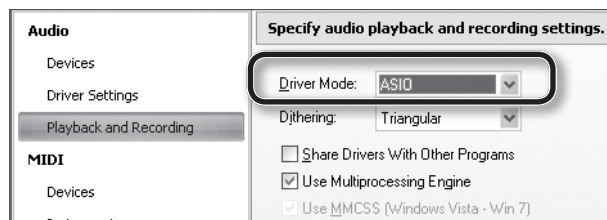

6. In the "Audio" section of the list at the left of the screen, choose [Select Device]. Clear the check marks from audio devices you're not using, and enter a check mark only for the INTEGRA-7.

Input device	Output device
INTEGRA-7 IN	INTEGRA-7 OUT

* When selecting INTEGRA-7 OUT as the output device, you need to set the "Ext Part Source Select" parameter under "Volume and Pitch Settings (SOUND)" (p. 48) to "USB AUDIO."

MIDI settings

Next, you need to specify the INTEGRA-7 as the MIDI input and output device.

7. In the "MIDI" section of the list at the left of the screen, choose [Select Device]. Enter a check mark for the INTEGRA-7, and clear the check marks from MIDI devices you're not using.

Input device	Output device
INTEGRA-7	INTEGRA-7

* When handling ordinary performance data, use "INTEGRA-7".
Use "INTEGRA-7 CTRL" (Windows only) when handling control data, such as that for MOTIONAL SURROUND.

8. Click [Apply].
9. In the "Preferences" dialog box, click [Close].

MEMO

If the INTEGRA-7 is not shown in the list of devices, close SONAR and try the operation again from step 2.

If it is still not shown, the driver installation might not have completed successfully. Uninstall the driver, and then install the driver once again.

Recording on a MIDI track

Connect the INTEGRA-7 to your computer as shown in “Connection example 1: A compact production setup” (p. 10).

* Turn the INTEGRA-7’s USB-MIDI Thru setting (p. 49) ON.

- 1. In the [File] menu, click [New].**
The “Create a New Project” dialog box will appear.
- 2. In the “Template” area, choose [Normal]; in the “Name” area, enter a name for your project and then click [OK].**
- 3. Record a MIDI track in SONAR.**
For details on how to record, refer to SONAR’s help.
- 4. Play back SONAR.**
You’ll hear sound from the INTEGRA-7.

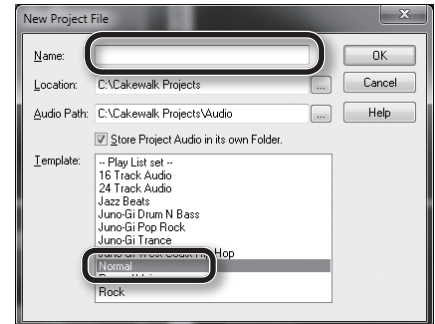

Recording the INTEGRA-7’s sound on an audio track

- 1. In the [Insert] menu, choose [Audio Track].**
One audio track will be added.
- 2. For the input field of the audio track, choose “Stereo INTEGRA-7 IN.”**

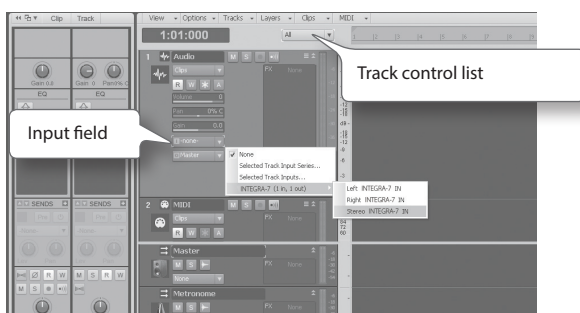

MEMO

If the input field is not shown, click the track control list and choose “ALL.”

- 3. Adjust the recording level.**
Put the track in recording-standby mode, then get the INTEGRA-7 to start playing. Adjust the input level of the SONAR so that the level meter reaches approximately -6 during the loudest passages.
* For details on the recording procedure, refer to SONAR’s help.
- 4. Record.**
Put the track in recording-standby mode, and press the record button of the transport module to begin recording.

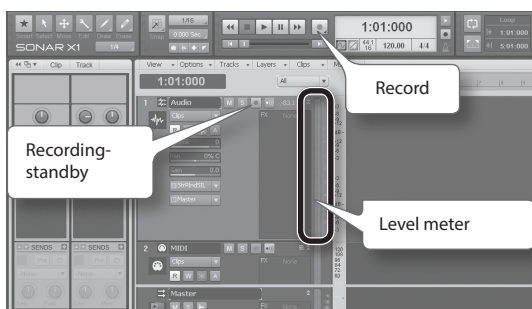

- 5. When the song ends, press the stop button.**
Recording will stop, and the recorded sound will be shown as a waveform in the audio track of SONAR.

Panel Descriptions

Front Panel

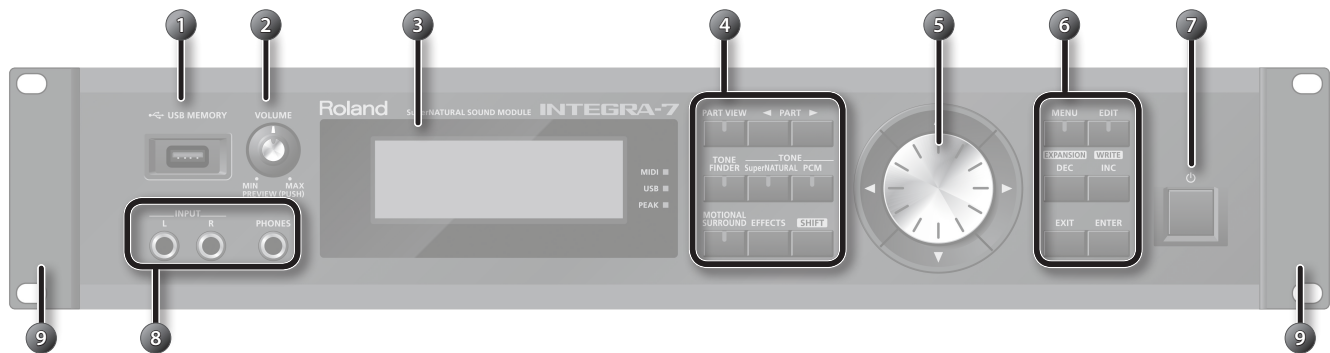

Number	Name	Explanation	Page
1	USB MEMORY port	Connect USB flash drive (sold separately) here. * Use USB Flash Memory available from Roland. Proper operation cannot be guaranteed if other USB device is used.	p. 50
2	[VOLUME] knob	Adjusts the volume of the output from the A (MIX) L/MONO, R jacks and PHONES jack. By pressing the [VOLUME] knob you can audition the tone of the currently selected part.	p. 21
3	Display	Shows various information for the operation. * The explanations in this manual include illustrations that depict what should typically be shown by the display. Note, however, that your unit may incorporate a newer, enhanced version of the system (e.g., includes newer sounds), so what you actually see in the display may not always match what appears in the manual.	p. 12
	MIDI indicator	This will light when MIDI messages are being received from a MIDI device connected to the MIDI IN connector.	–
	USB indicator	This will light when MIDI messages are being received from the connected computer.	–
	PEAK indicator	This will light when the input signal from the INPUT L/R jacks reaches a level just before clipping.	–
4	[PART VIEW] button	Switches you between the screen that lists all parts, the PART VIEW screen, and the top screen. By holding down the [SHIFT] button and pressing the [PART VIEW] button, you can access the Studio Set select screen.	p. 30
	PART [◀] [▶] buttons	These switch the part shown in the screen.	p. 28
	[TONE FINDER] button	Accesses the TONE FINDER screen.	p. 31
	TONE [SuperNATURAL] button	Changes the tone of the currently selected part to a SuperNATURAL tone, and displays the tone list.	p. 31
	TONE [PCM] button	Changes the tone of the currently selected part to a PCM tone, and displays the tone list.	p. 31
	[MOTIONAL SURROUND] button	Turns on motional surround, and displays the MOTIONAL SURROUND screen. By holding down the [SHIFT] button and pressing the [MOTIONAL SURROUND] button, you can access the MOTIONAL SURROUND screen without changing the motional surround on/off setting.	p. 34
	[EFFECTS] button	Pressed to access the EFFECTS ROUTING screen.	p. 36, p. 41
5	[SHIFT] button	This is used in conjunction with other buttons to access setting screens related to those buttons.	p. 29
	Cursor [▲] [▼] [◀] [▶] button	Move the cursor up/down/left/right.	p. 28
6	Value dial	Use this to edit values. To make the value change rapidly, operate the value dial while holding down the [SHIFT] button.	p. 28
	[MENU] button	Accesses the Menu screen. By holding down the [SHIFT] button and pressing the [MENU] button, you can access the EXPANSION (VIRTUAL SLOT) screen.	–
	[EDIT] button	Displays the TONE EDIT screen for the currently selected part. By holding down the [SHIFT] button and pressing the [EDIT] button, you can access the WRITE screen.	p. 38
	[DEC]/[INC] buttons	Use these buttons to edit values. To make the change occur more rapidly, hold down one button and press the opposite button. You can also make the value change rapidly by holding down the [SHIFT] button and pressing one of these buttons.	p. 28
	[EXIT] button	Returns you to the previous screen, or closes the window that's currently open. In some screens, this cancels the operation currently being executed.	–
7	[ENTER] button	Press this to confirm a value or execute an operation.	–
	[⏻] switch	Turns the INTEGRA-7 on/off.	p. 21
8	INPUT L/R jacks (front)	You can connect a synthesizer or other instrument here. If an instrument is also connected to the INPUT L/R jacks (rear), the sounds of both will be mixed.	p. 47
	PHONES jacks	You can connect headphones (sold separately) here.	–
9	Rack-mount bracket	Use these when installing the INTEGRA-7 in a 19-inch rack. For details on how to install the INTEGRA-7 in a rack, refer to the owner's manual included with the rack you're using. * Do not remove the rack-mount brackets.	–

Turning the INTEGRA-7 On/Off

Once everything is properly connected (p. 22), be sure to follow the procedure below to turn on their power. If you turn on equipment in the wrong order, you risk causing malfunction or equipment failure.

Turning the INTEGRA-7 On

Before turning the unit on/off, always be sure to turn the volume down. Even with the volume turned down, you might hear some sound when switching the unit on/off. However, this is normal and does not indicate a malfunction.

1. Minimize the volume of the INTEGRA-7 and your speakers.

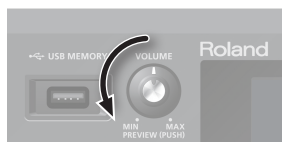

2. Turn the INTEGRA-7's [⏻] switch ON.

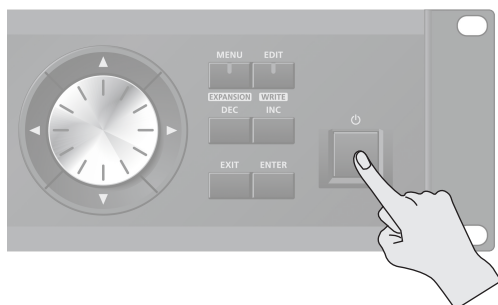

This unit is equipped with a protection circuit. A brief interval (a few seconds) after turning the unit on is required before it will operate normally.

3. Turn on the power of your speakers.
4. Use the [VOLUME] knob to adjust the volume appropriately.



NOTE

With the factory settings, the INTEGRA-7 will automatically be switched off four hours after you stop playing or operating the unit. If you don't want the unit to turn off automatically, change the "Auto Off" setting to "OFF" as described on p. 55.

- * The settings you were editing will be lost when the unit is turned off. If you want to keep your settings, you must save your settings before turning the unit off.
- * When turning the unit back on after it was turned off by the Auto-Off function, you must wait at least 10 seconds before turning the unit on. If you do not allow this interval to pass, the Auto-Off function might not be reset, and the unit might not turn on normally.

Turning the INTEGRA-7 Off

1. Minimize the volume of the INTEGRA-7 and your speakers.
2. Turn off the power of your speakers.
3. Turn the INTEGRA-7's [⏻] switch OFF.

NOTE

If you need to turn off the power completely, first turn off the unit, then unplug the power cord from the power outlet. Refer to **Power Supply** (p. 5).

Playing the Demo Song

1. Press the [MENU] button.
2. Choose "DEMO PLAY" and press the [ENTER] button.
3. Choose a demo song and press the [ENTER] button.

The demo song will play.

- * The performance data for the demo song will not be output from the MIDI OUT connector.
- * If you want sound to be produced from the front center / subwoofer of your 5.1 channel speaker system, turn the 5.1CH Center SP Switch / Sub Woofer(LFE) Switch "ON."

MEMO

The DEMO MENU screen can also be accessed by pressing the [EXIT] button while holding down the [SHIFT] button.

Rear Panel Connections

AC IN jack

Connect the included AC cord here.

INPUT L/R jacks (rear)

Use audio cables to connect a synthesizer or other instrument here.

If an instrument is also connected to the INPUT L/R jacks (front), the sounds of both will be mixed.

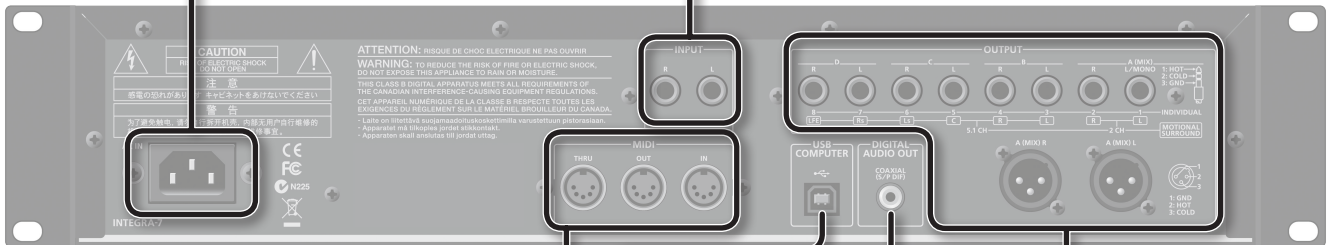

MIDI connectors

For connecting MIDI device.

page 11

OUTPUT jacks

You can switch the output between stereo, mono, and 5.1 channel surround.

For details on connections, refer to p. 23.

* Only the A (MIX) L/MONO, R jacks are balanced.

page 23

USB COMPUTER port

With a USB cable, you can connect the INTEGRA-7 to your computer.

page 44



DIGITAL AUDIO OUT connector

This is a coaxial digital output connector. It complies with S/P DIF specifications. It outputs the same signal as is output from the OUTPUT A (MIX) jacks.

It provides 44.1/48/96 kHz, 24-bit linear, stereo output.

OUTPUT jacks

(When motional surround (p. 34) is OFF)

A (MIX) L/MONO, R jacks

These jacks output a stereo signal (L/R) to your amp or mixer. If you want to output in mono, connect to only the L side. Both XLR type and TRS type jacks are provided; they output the same audio.

B, C, D L/R jacks

These jacks output a stereo signal (L/R) to your amp or mixer.

* The [VOLUME] knob on the front panel does not adjust the volume of these jacks.

INDIVIDUAL 1-8 jacks

These jacks output mono signals to your amp or mixer.

* The [VOLUME] knob on the front panel does not adjust the volume of INDIVIDUAL 3-8 jacks.

* The output destination (A-D, 1-8) can be assigned independently for each part "Output Assign" (p. 32).

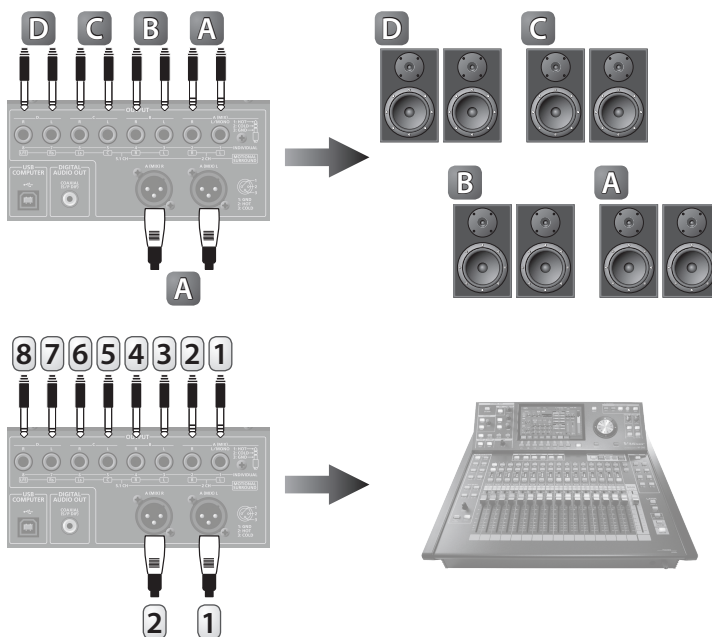

OUTPUT jacks

(When motional surround (p. 34) is ON)

Supports both two-channel and 5.1 channel surround output.

MOTIONAL SURROUND 2 CH L/R jacks

These jacks allow two speakers to output sound with spatial depth as specified by the motional surround settings.

The same audio will be output from the TRS type and the XLR type jacks.

MOTIONAL SURROUND 5.1 CH L/R/C/Ls/Rs/LFE jacks

These jacks output 5.1 channel surround as specified by the motional surround settings.

Position your speakers as shown in the illustration.

* The [VOLUME] knob on the front panel does not adjust the volume of these jacks.

* Two-channel and 5.1 channel surround are output simultaneously.

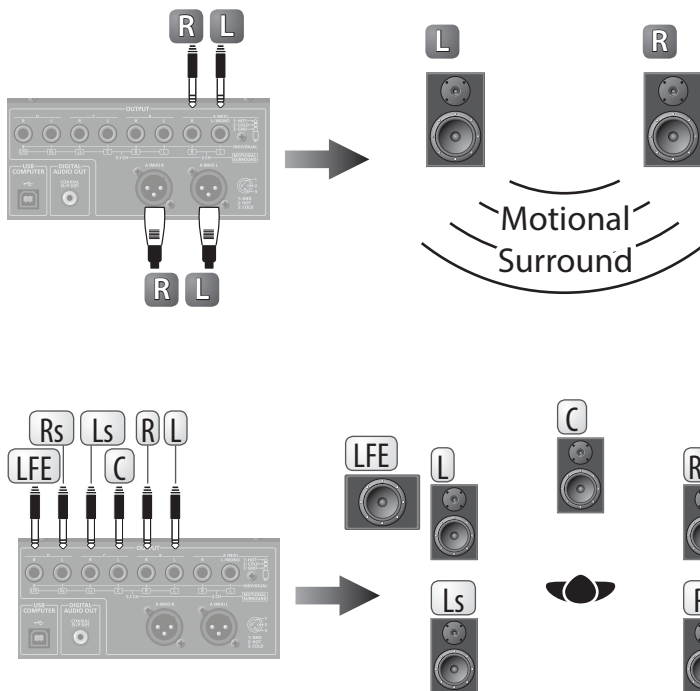

* To prevent malfunction and equipment failure, always turn down the volume, and turn off all the units before making any connections.

* This instrument is equipped with balanced (XLR/TRS) type jacks. Wiring diagrams for these jacks are shown below. Make connections after first checking the wiring diagrams of other equipment you intend to connect.



* When connection cables with resistors are used, the volume level of equipment connected to the input jacks (front, rear) may be low. If this happens, use connection cables that do not contain resistors.

Getting Acquainted with the INTEGRA-7

Studio Sets

Studio Sets allow you to use multiple tones and drum kits simultaneously.

One studio set contains 16 “parts” for tones and one external part (EXT PART). You can assign a tone or drum kit to each part, allowing you to create an ensemble or to play rich-sounding layers.

If you’re using an external MIDI device or DAW software, you’ll be able to independently control multiple sounds on a single INTEGRA-7 unit.

How a Tone Is Structured

A “tone” is a unit of sound used when performing. There are “SuperNATURAL tones” and “PCM tones,” each containing their own effect (MFX) settings.

You need to select a tone from the sound library and assign it to a part. You can also edit a tone and save it in user memory.

USB AUDIO
or
INPUT (Front/Rear)

SuperNATURAL Tone

There are three types of SuperNATURAL tones: “SuperNATURAL acoustic tones,” “SuperNATURAL synth tones,” and “SuperNATURAL drum kits.”

SuperNATURAL Acoustic Tone (p. 38)

These tones do not merely reproduce the sound of acoustic instruments, they also use behavior modeling technology appropriate for the selected tone to emulate the expressive power distinctive of each acoustic instrument, such as the phrases performed by the player and the differences between chords and melodic phrases.

SuperNATURAL Synth Tone (p. 38)

These tones consist of three partials, and allow powerful synth sounds to be produced by a single tone.

SuperNATURAL Drum Kit (p. 39)

These tones consist of 62 partials; they allow you to sound a different percussion instrument for each key (note number) that’s played.

A drum kit is provided with six compressor + equalizer units, allowing you to divide the instruments into groups so that you can individually adjust the dynamics of each group or modify its tone quality.

PCM Tone

There are two types of PCM tones: “PCM synth tones” and “PCM drum kits.”

PCM Synth Tone (p. 39)

These tones consist of four partials. Each partial can be turned on/off individually, allowing you to choose which partials will be heard.

PCM Drum Kit (p. 40)

These consist of 88 partials, and allow for the play of a different percussion instrument sound for each key (note number) you press. A drum kit is provided with six compressor + equalizer units, allowing you to divide the instruments into groups so that you can individually adjust the dynamics of each group or modify its tone quality.

* The six compressor + equalizer units for a drum kit are applied only to one specified part of the multiple parts to which a drum kit can be assigned. Make this setting in STUDIO SET COMMON (p. 32).

* Dedicated multi-effect settings are included in each tone (SuperNATURAL tones and PCM tones) built into the INTEGRA-7.

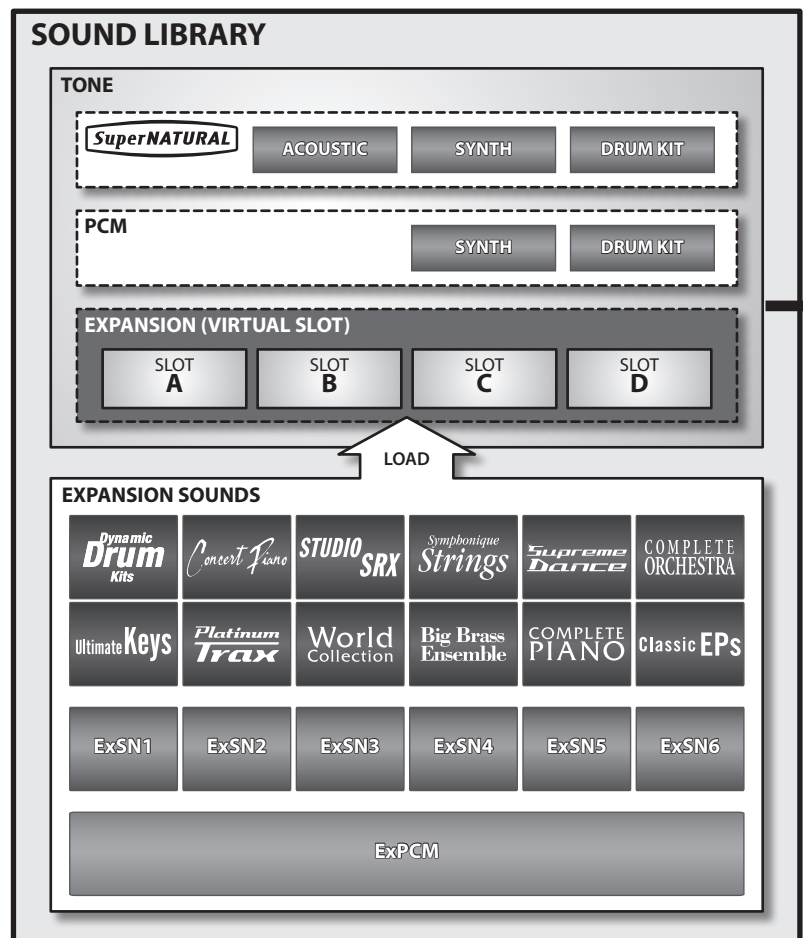

EXPANSION Virtual Slots

EXPANSION Virtual Slots are banks into which you can load “EXPANSION SOUNDS” sound data for use.

“SRX tones,” “SuperNATURAL tones,” or “ExPCM (GM2 compatible) tones” can be loaded into an EXPANSION Virtual Slot. “ExPCM tones” use all four slots, meaning that they do not allow other tones to be loaded.

For details, refer to “04 Using the Expansion Sounds” (p. 14).

How a Studio Set Is Structured

A studio set has sixteen parts; you can assign a tone to each part, allowing you to use sixteen sounds simultaneously.

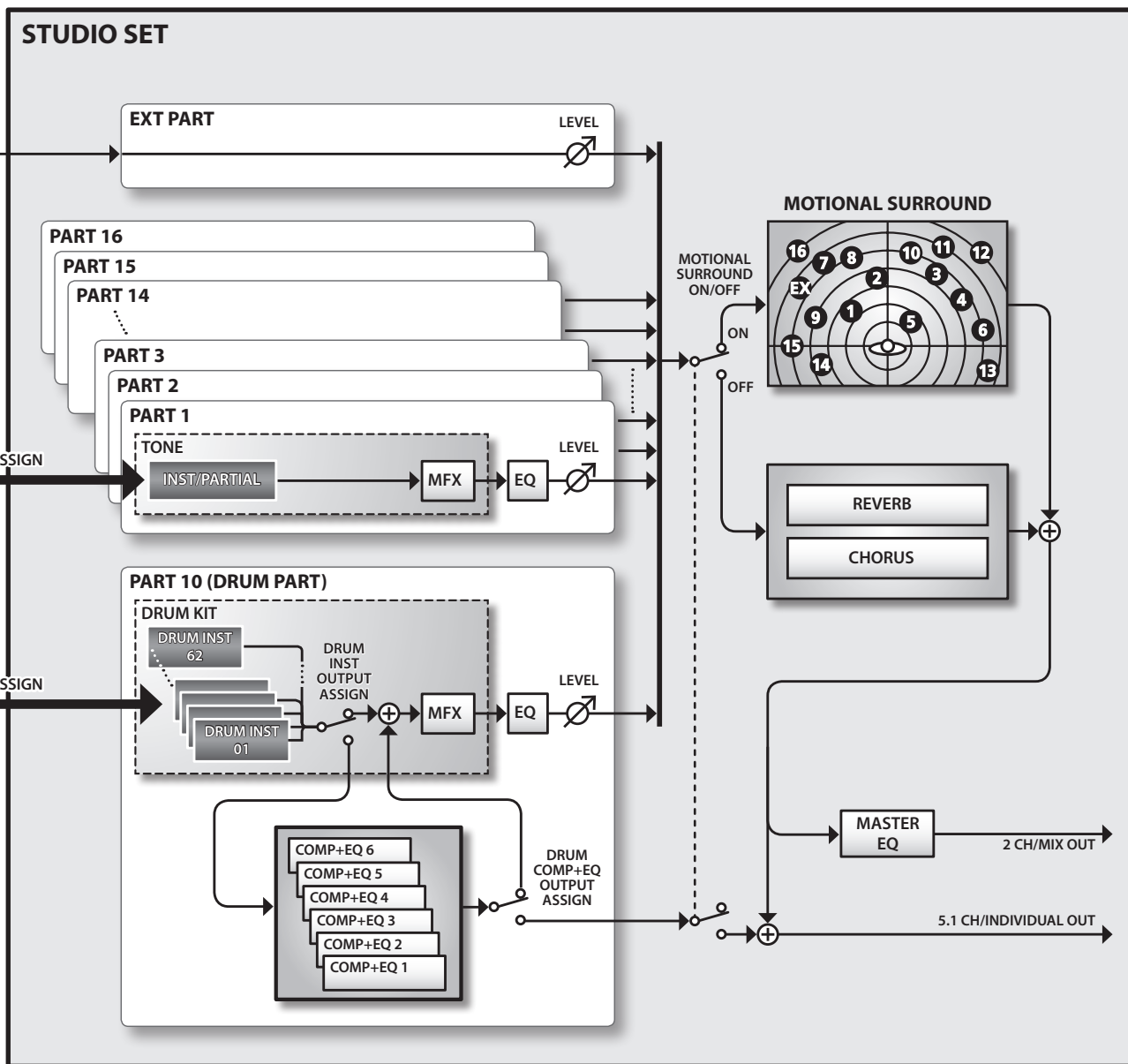

* Although you are free to assign a drum kit to any or all of the parts, we have assigned a drum kit to part 10 and a tone to the remaining parts as an example.

Bank

Tones are organized into groups called "banks."

Part

A "part" is a location to which you can assign a tone or drum kit in order to play it on the INTEGRA-7.

Partial

A "partial" is a unit of sound within a SuperNATURAL synth tone (p. 38), SuperNATURAL drum kit (p. 39), PCM synth tone (p. 39), or PCM drum kit (p. 40). These tones consist of multiple partials.

Inst

An "inst" is the smallest unit of sound within a SuperNATURAL acoustic tone (p. 38). Each SuperNATURAL acoustic tone consists of a single "inst."

Effects

The INTEGRA-7 contains the following effects; each effect can be edited independently.

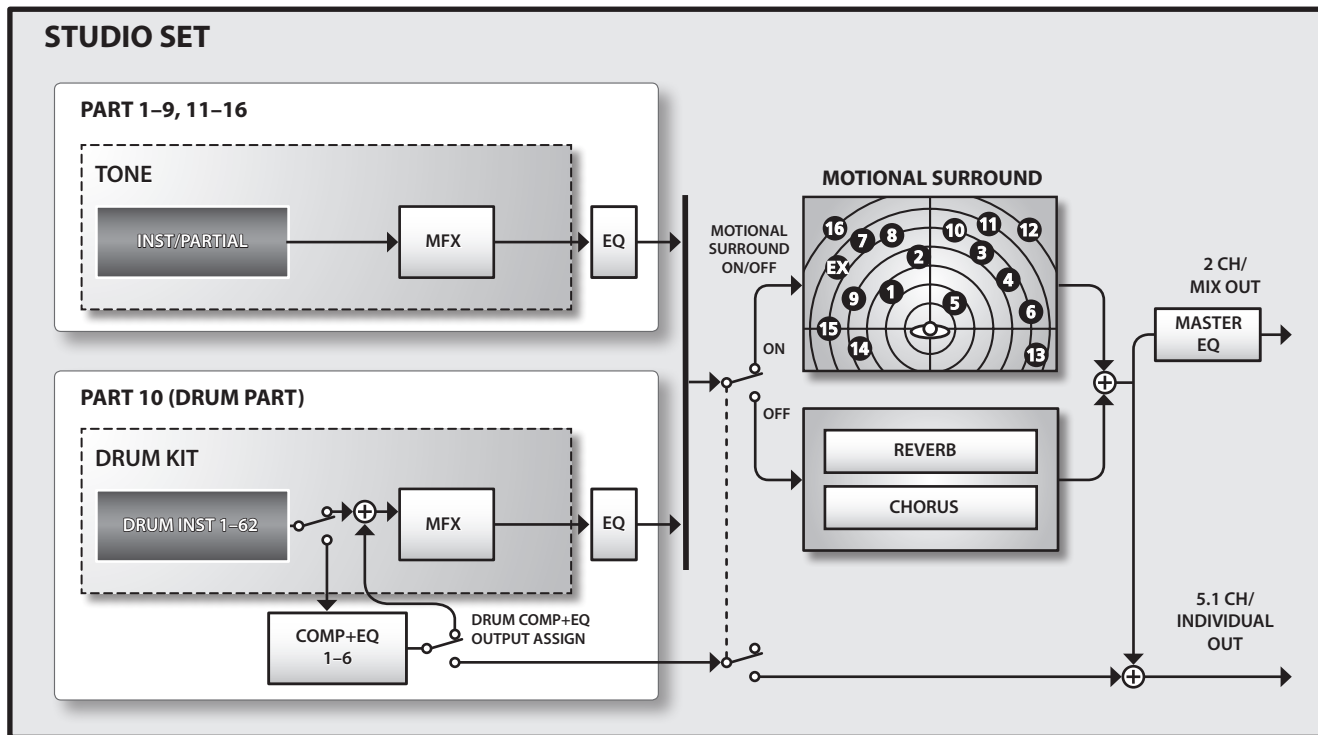

Effects for a Tone

Multi-effects (MFX)

These are general-purpose effects that can modify the sound itself, even transforming it into an entirely different type of sound.

You can choose from 67 types of effects as appropriate for your purpose.

There are types that consist of a single effect, such as distortion or flanger, as well as a wide variety of other types. Although the multi-effect types also include chorus, this is a separate processor that is independent of the chorus unit of a studio set.

Each tone has one set of multi-effect settings.

Compressor + Equalizer (COMP + EQ)

A drum part allows you to use six compressor + equalizer units. They can be assigned individually to the drum instruments.

* Although it is possible to assign drum kits to all of the parts, the six compressor + equalizer sets provided for a drum kit will be available only for the single part you specify (the Drum COMP + EQ Assign part).

Effects for a Studio Set

Equalizer (EQ)

This equalizer is applied to each individual part.

It allows you to independently adjust the high, mid, and low-frequency ranges.

MOTIONAL SURROUND

Motional surround allows you to not only position a sound anywhere between the left and right edges of the sound field, but also allows you to move it towards the front or rear.

Two-channel and 5.1 channel output is supported, allowing you to place each instrument at the desired depth.

* When you turn Motional Surround on, reverb/chorus will not be applied.

CHORUS

The chorus effect adds depth and spaciousness to the sound.

* Motional Surround and chorus cannot be applied at the same time.

REVERB

The reverb effect adds the reverberation that is characteristic of sounds played in a concert hall.

You can choose from six types of reverb as appropriate for your needs.

* Motional Surround and reverb cannot be applied at the same time.

MASTER EQ

This equalizer is applied to the overall sound of the entire INTEGRA-7 sound module.

It allows you to independently adjust the high, mid, and low-frequency ranges.

About Memory

Memory is where data such as the settings for studio sets and tones are held.

There are three types of memory: “temporary memory” (the temporary area, and the EXPANSION Virtual Slots), “rewritable memory” (user memory, system memory, and USB memory), and “non-rewritable memory” (preset memory).

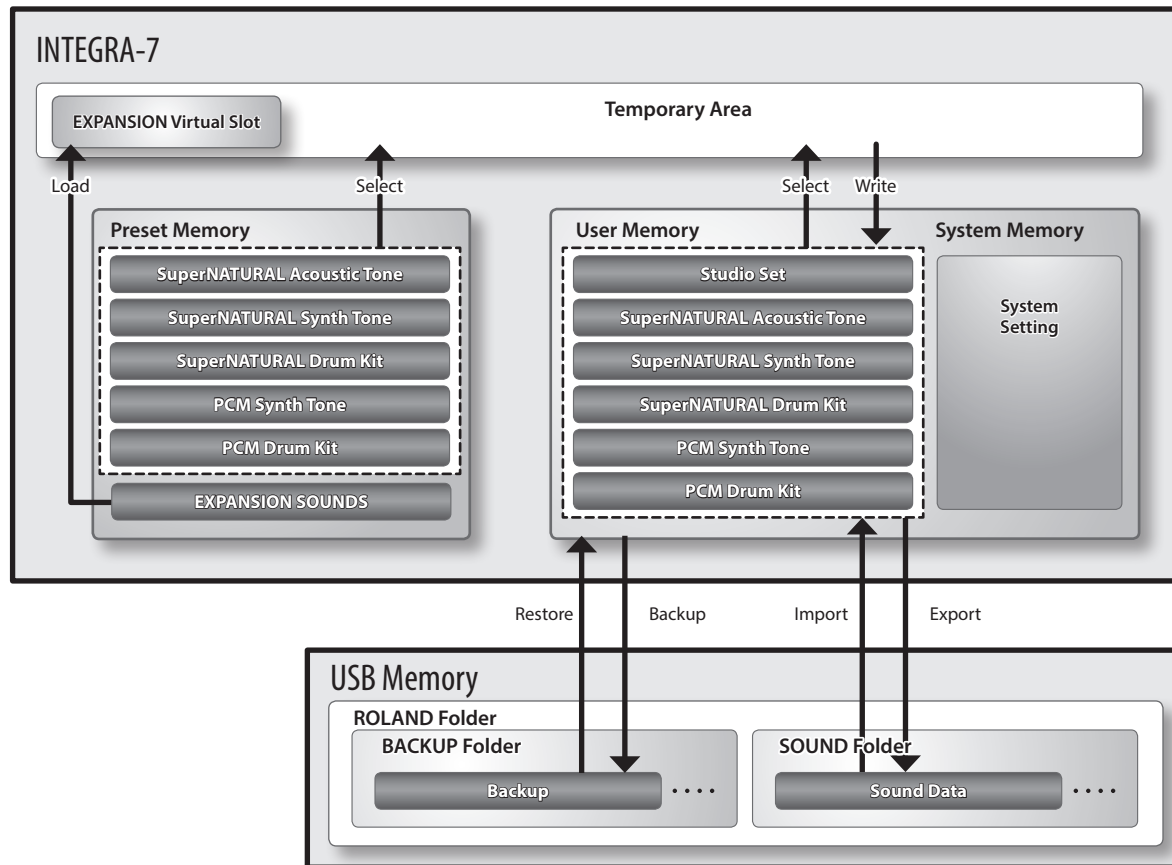

Temporary memory

Temporary Area

This area temporarily holds the data of the studio set or tone that you've selected from the panel.

When you play, the INTEGRA-7 produces sound according to the settings in the temporary area. When you edit a studio set or a tone, you're not directly modifying the data in that memory; rather, the data is called into the temporary area, and your editing modifies this data.

Settings in the temporary area are temporary, and will be lost when you turn off the unit or call up other settings. If you want to keep the settings of the temporary area, you must execute the Write operation (p. 29) to save them into rewritable User Memory.

EXPANSION Virtual Slots

Sound data from EXPANSION SOUNDS can be loaded into these memory locations to expand the available sounds.

You can load four titles of SRX or SuperNATURAL sound data into these virtual slots.

Rewritable memory

System Memory

This is memory that holds the system parameter settings that specify how the INTEGRA-7 is to operate. To store the system parameters, execute the System Write operation (p. 48).

User Memory

This is memory that stores data inside the INTEGRA-7. To store a studio set, execute Studio Set Write (p. 34). To store a tone, execute Tone Write (p. 40). To store a drum kit, execute Drum Kit Write (p. 40).

* EXPANSION SOUNDS sound data that you've edited in the temporary area can be saved in user memory, but it will not be audible unless the EXPANSION SOUNDS used by that sound data have been loaded into an EXPANSION Virtual Slot.

USB Memory

You can use a USB flash drive to back up all of the studio sets, tones, and drum kits in User Memory, together with the system parameters from System Memory, as a single collection of data (p. 52).

Of the studio sets and tones saved in the INTEGRA-7, you can select the desired sound data and export it to a USB flash drive. You can also select a desired studio set or tone from a file that was previously exported to a USB flash drive, and import it.

Non-rewritable Memory

Preset Memory

The data in preset memory cannot be rewritten.

However, settings loaded from preset memory into the temporary area can be edited and then stored in user memory.

Basic Operation

This section explains the basic button operations used to operate the INTEGRA-7.

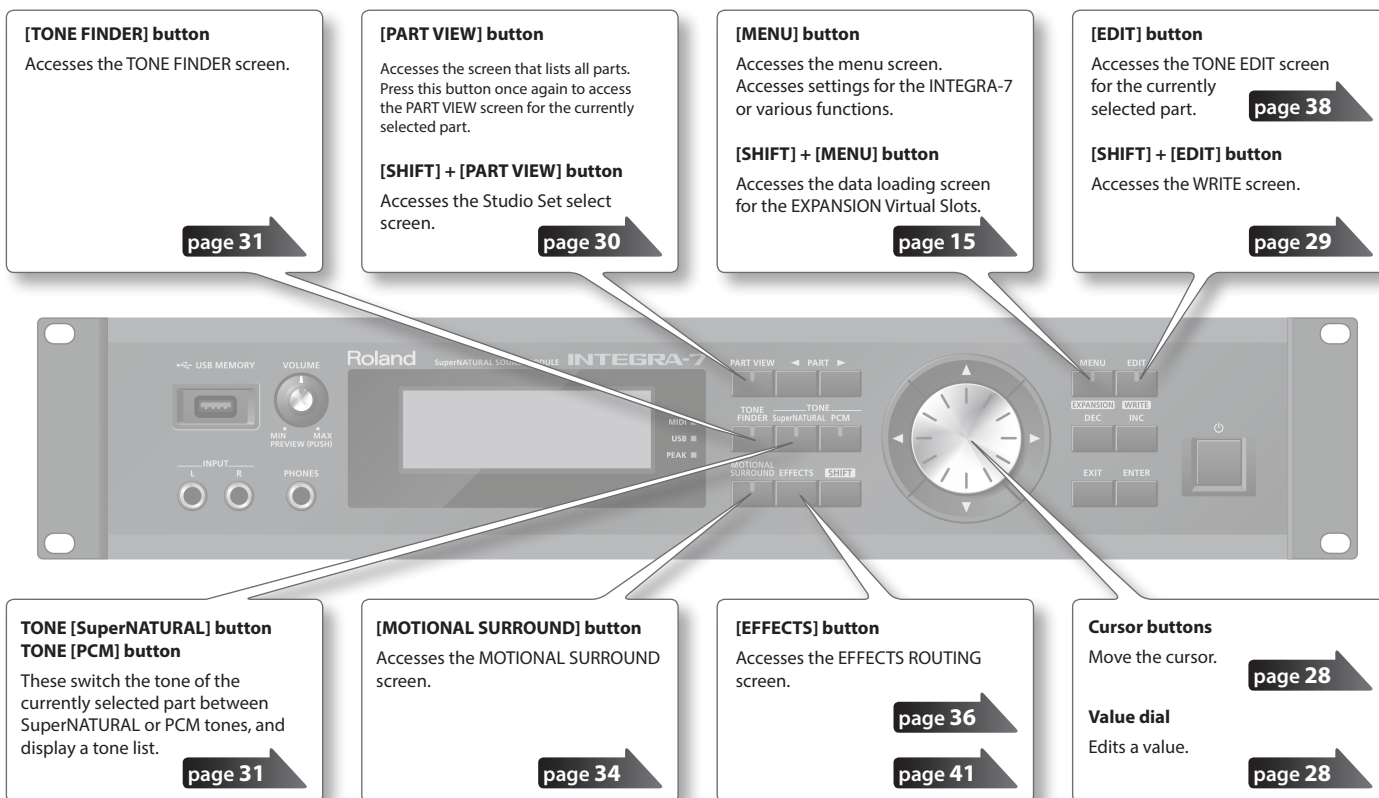

Switching Parts

Here's how to switch the part that's shown in the screen or is selected (the "current part").
In the top screen, the current part is indicated by a ▲ symbol below the part number.

PART [◀] [▶] buttons

Press the PART [▶] button to switch to the next part. Press the PART [◀] button to switch to the previous part.
If you hold down the PART [◀] or PART [▶] button, the part will change successively.
The part will switch more rapidly if you press the PART [▶] (or PART [◀] button) while holding down the PART [◀] (or PART [▶] button).

Moving the Cursor

A single screen or window will contain multiple items (parameters) to edit or select. To edit a parameter's setting, you must first move the cursor to that parameter's value.
The value of the selected parameter is highlighted.

Cursor buttons

You can move the cursor by pressing the cursor [▲] [▼] [◀] [▶] buttons.
If you hold down a cursor button, the cursor will continue moving.
If you hold down the cursor button for the desired direction, and then press the opposite cursor button, the cursor will move more quickly.

Editing a Value

To edit the value highlighted by the cursor, use either of the following controllers.

- Value dial
- [DEC] [INC] button

Value dial

Turning the value dial toward the right will increase the value, and turning it toward the left will decrease the value.

If you hold down the [SHIFT] button while turning the value dial, the value will change in larger steps.

[DEC] [INC] buttons

Press the [INC] button to increase the value, or press the [DEC] button to decrease the value.

- If you hold down a button, the value will increase (or decrease) continuously.
- To rapidly increase the value, hold down the [INC] button and press the [DEC] button. Conversely, to rapidly decrease the value, hold down the [DEC] button and press the [INC] button.
- If you hold down the [SHIFT] button and press the [INC] button or [DEC] button, the value will change in larger steps.

Playing Sounds

Choosing a Studio Set

A Studio Set stores the sounds selected for each Part, as well as various performance-related settings (except for system parameters).

By switching studio sets you can change sounds at the beginning of a song or change large numbers of settings at once.

NOTE

If you're selecting a studio set that uses tones from an EXPANSION Virtual Slot, you won't hear anything unless the corresponding sound data is loaded.

1. Press the [MENU] button.
2. Choose "STUDIO SET SELECT" and press the [ENTER] button.

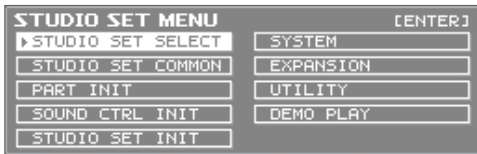

3. Use the value dial to select a Studio Set.
4. Press the [ENTER] button.

The studio set will be switched.

MEMO

You can also access the STUDIO SET selection screen by holding down the [SHIFT] button and pressing the [PART VIEW] button.

Viewing a List of All Parts (PART VIEW -ALL- Screen)

In this screen you can edit the part parameters while viewing a list of all parts.

* Some of the part parameters are not shown.

1. Press the [PART VIEW] button.

Part	Level	Pan	Cho	Rev	Output	Sw	Ch
01	100	0	0	20	A	ON	1
02	100	0	0	20	A	ON	2
03	100	0	0	20	A	ON	3
04	100	0	0	20	A	ON	4
05	100	0	0	20	A	ON	5

2. Use the cursor buttons to select the item that you want to edit, and use the value dial to edit the value.

By holding down the [SHIFT] button and pressing a cursor [◀] [▶] button you can switch between tabs.

Viewing the Part Settings (PART VIEW Screen)

In this screen you can edit the part parameters while focusing on a single part.

1. In the top screen, press the [PART VIEW] button twice.

LEVEL/CH	VER	KBD	PITCH	OFFSET	SCALE	TR	B
Level	100						
Pan	0					Rx Switch	ON
Cho Send Level	0					Rx Channel	1
Rev Send Level	20					Mono/Poly	TONE
Output Assian	A					Lesato Switch	TONE
						Voice Reserve	0

2. Use the PART [◀] [▶] buttons to select the part that you want to change.
3. Use the cursor buttons to select the item that you want to edit, and use the value dial to edit the value.

Temporarily Silencing a Part's Sound (MUTE)

Here's how to temporarily mute (silence) the sound of each part.

1. In the top screen, move the cursor to "MUTE."
2. Use the PART [◀] [▶] buttons to select the part that you want to mute (silence).
3. Use the [DEC] [INC] buttons to turn mute on/off.

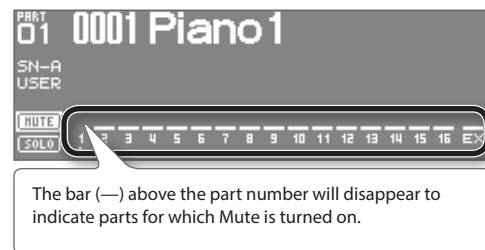

Listening to Only One Part (SOLO)

Here's how you can listen to only the sound of the currently selected part.

1. In the top screen, move the cursor to "SOLO."

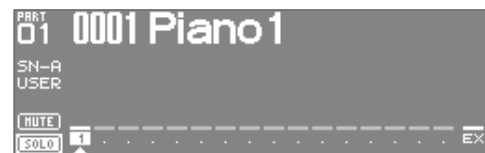

Only the selected part will be heard.

2. Use the PART [◀] [▶] buttons to select the part that you want to hear.
3. Use the [DEC] [INC] buttons to turn solo on/off.

MEMO

If you switch parts while solo is on, the soloed part will also change.

Choosing a Tone

In the PART VIEW screen you can select the tone for each part. You can view the tone list by category or by type.

Tone Preview function

By pressing the [VOLUME] knob you can audition the tone of the selected part.

Selecting Tones from a Tone List by Category

1. Press the [TONE FINDER] button.

The tone list organized by category will appear.



2. Use the cursor [◀][▶] buttons to switch categories.
3. Use the value dial or the cursor [▲][▼] buttons to select a tone, and press the [ENTER] button.

MEMO

By holding down the [SHIFT] button and using the cursor [▲][▼] buttons, you can switch to the next (or previous) type/bank.

Selecting Tones from a Tone List by Type/Bank

1. Press the [SuperNATURAL] or [PCM] button.

The tone list will appear.



2. Use the cursor buttons to switch the type or bank tab.
3. Use the value dial or the cursor [▲][▼] buttons to select a tone, and press the [ENTER] button.

Selecting Drum Kits from a Tone List

1. Press the [SuperNATURAL] or [PCM] button.

The tone list will appear.

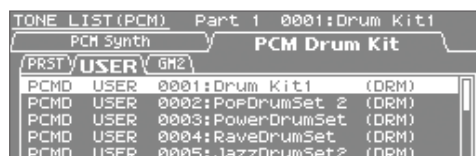

2. Use the cursor buttons to select the drum kit tab.

Select the "SN Drum Kit" tab for SuperNATURAL tones, or the "PCM Drum Kit" tab for PCM tones.

3. Use the value dial or the cursor [▲][▼] buttons to select a drum kit, and press the [ENTER] button.

Editing a Studio Set

Studio Set Common Settings

Here you can make settings that are common to the entire studio set.

1. In the Top screen, press the [MENU] button.
2. Choose "STUDIO SET COMMON" and press the [ENTER] button.

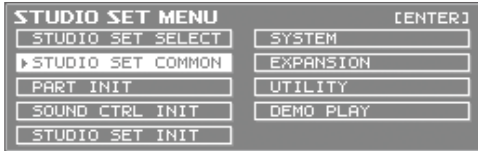

3. Use the cursor buttons to select an item, and use the value dial to edit the value of that item.

COMMON parameter

MEMO

For details on the part parameters, refer to "Parameter Guide PDF."

Tab	Explanation
GENERAL	Specifies the tempo of the studio set, and the drum part to which COMP+EQ will be applied.
CONTROL	When using tone controls 1–4, specifies the MIDI messages that will control the parameters.
PHASE LOCK	Turn this "on" if you want to minimize discrepancies in timing between notes played by parts on the same MIDI channel.

Editing the Part Settings

A studio set contains 16 parts; you can edit settings such as volume (Level), equalizer (EQ), and key range (KBD) for each part.

1. In the top screen, press the [PART VIEW] button twice.

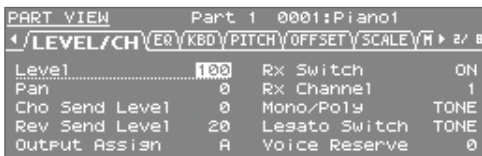

2. Use the cursor buttons to select the item that you want to edit, and use the value dial to edit the value.

By holding down the [SHIFT] button and pressing a cursor [◀] [▶] button you can switch between tabs.

MEMO

For details on the part parameters, refer to "Parameter Guide PDF."

Parts 1–16

Tab	Parameter	Value
TONE	TYPE	Displays/selects the tone type.
	BANK	Displays/selects the tone bank.
	Tone Number	Displays/selects the tone number. The tone name is shown at the right.

Tab	Parameter	Value
LEVEL	Level	Adjust the volume of each part. This setting's main purpose is to adjust the volume balance between parts.
	Pan	Adjust the pan of each part. "L64" is far left, "0" is center, and "63R" is far right. * This has no effect if Motional Surround is on.
	Cho Send Level	Sets the level of the signal sent to chorus for each part. Set this to 0 if you don't want to apply chorus.
	Rev Send Level	Sets the level of the signal sent to reverb for each part. Set this to 0 if you don't want to apply reverb.
	Output Assign	Specifies for each part how the direct sound will be output. If Motional Surround is on, surround output will be enabled, and this setting will be ignored.
	Rx Switch	For each part, specify whether it will receive MIDI data (ON) or ignore it (OFF).
	Rx Channel	Specifies the MIDI channel of each part.
	Mono/Poly (*)	Sets how the Patch's notes play. The MONO setting is effective when playing a solo instrument Patch such as sax or flute.
	Legato Switch (*)	Turn this parameter "ON" when you want to use the Legato feature and "OFF" when you don't. Legato is a feature that works only when the Mono/Poly is MONO. When Legato is ON, pressing one key when another is already pressed causes the currently playing note's pitch to change to that of the newly pressed key while continuing to sound. This can be effective when you wish to simulate performance techniques such as a guitarist's hammering on and pulling off strings. * This setting is ignored for parts to which a tone is assigned.
	Voice Reserve (*)	Specifies the number of voices that reserved for each Part when more than 128 voices are played simultaneously.
EQ	EQ Switch	Turn this "ON" if you want to use the equalizer, or "OFF" if you don't.
	EQ Low Freq (*)	Specifies the frequency of the low range.
	EQ Low Gain	Specifies the amount of boost/cut for the low range.
	EQ Mid Freq (*)	Specifies the frequency of the mid range.
	EQ Mid Gain	Specifies the amount of boost/cut for the mid range.
	Q (*)	Specifies the width of the mid range. Higher values make the range narrower.
	EQ High Freq (*)	Specifies the frequency of the high range.
EQ High Gain	Specifies the amount of boost/cut for the high range.	
KBD	Key Fade Upper	This determines what will happen to the tone's level when a note that's higher than the tone's specified keyboard range is played. Higher settings produce a more gradual decrease in volume. If you don't want the tone to sound at all when a note outside the keyboard range is played, set this parameter to "0."
	Key Range Upper	Specifies the highest note that the tone will sound for each tone. * If you attempt to raise the lower key higher than the upper key, or to lower the upper key below the lower key, the other value will be automatically modified to the same setting.
	Key Range Lower	Specifies the lowest note that the tone will sound for each tone.
	Key Fade Lower	This determines what will happen to the tone's level when a note that's lower than the tone's specified keyboard range is played. Higher settings produce a more gradual decrease in volume. If you don't want the tone to sound at all when a note outside the keyboard range is played, set this parameter to "0."

Tab	Parameter	Value
KBD	Velo Fade Upper (*)	This determines what will happen to the tone's level when the tone is played at a velocity greater than its specified velocity range. Higher settings produce a more gradual decrease in volume. If you want notes played outside the specified key velocity range to not be sounded at all, set this to "0."
	Velo Range Upper (*)	This specifies the upper limit of the velocities that will sound the tone. Edit this setting if you want to use velocity to switch between tones. * If you attempt to set the Lower velocity limit above the Upper, or the Upper below the Lower, the other value will automatically be adjusted to the same setting.
	Velo Range Lower (*)	This specifies the lower limit of the velocities that will sound the tone. Edit this setting if you want to use velocity to switch between tones.
	Velo Fade Lower (*)	This determines what will happen to the tone's level when the tone is played at a velocity lower than its specified velocity range. Higher settings produce a more gradual decrease in volume. If you want notes played outside the specified key velocity range to not be sounded at all, set this to "0."
	Velo Sens Offset (*)	Applies an offset to the velocity sensitivity for the entire tone, while preserving the differences between velocity sensitivity values.
PITCH	Octave Shift	Adjusts the pitch of the part's sound up or down in units of an octave (over a range of +/-3 octaves).
	Coarse Tune	Adjusts the pitch of the part's sound up or down in semitone steps (over a range of +/-4 octaves).
	Fine Tune	Adjusts the pitch of the part's sound up or down in 1-cent steps (over a range of +/-50 cents).
	Bend Range	Specifies the amount of pitch change in semitones (over a range of 2 octaves) that will occur when the Pitch Bend Lever is moved. The amount of change when the lever is tilted is set to the same value for both left and right sides.
	Porta Switch (*)	Specifies whether the portamento effect will be applied (ON) or not (OFF). * Portamento is an effect which smoothly changes the pitch from the first-played key to the next-played key. By applying portamento when the Mono/Poly parameter is "MONO," you can simulate slide performance techniques on a violin or similar instrument.
	Porta Time (*)	When portamento is used, this specifies the time over which the pitch will change. Higher settings will cause the pitch change to the next note to take more time.
OFFSET	Cutoff Offset	Adjusts the cutoff frequency for the tone or drum kit assigned to a part.
	Reso Offset	Adjusts the Resonance for the tone or drum kit set assigned to a part.
	Attack Offset	Adjusts the Attack Time for the tone or drum kit assigned to a part.
	Decay Offset	Adjusts the Decay Time for the tone or drum kit assigned to a part.
	Release Offset	Adjusts the Release Time for the tone or drum kit assigned to a part.
	Vibrato Rate (*)	For each part, adjust the vibrato speed (the rate at which the pitch is modulated). The pitch will be modulated more rapidly for higher settings, and more slowly with lower settings.
	Vibrato Depth (*)	For each part, this adjusts the depth of the vibrato effect (the depth at which the pitch is modulated). The pitch will be modulated more greatly for higher settings, and less with lower settings.

Tab	Parameter	Value
OFFSET	Vibrato Delay (*)	For each part, this adjusts the time delay until the vibrato (pitch modulation) effect begins. Higher settings will produce a longer delay time before vibrato begins, while lower settings produce a shorter time.
	Type	If you want to play the keyboard using a tuning other than equal temperament, you can choose an alternative tuning such as just intonation (major, minor) or an Arabian scale.
SCALE	Key	When using a tuning other than equal temperament, choose the tonic that's appropriate for the key of the song you're playing (i.e., the note corresponding to "C" for major, or "A" for minor). If you're using equal temperament, there's no need to select the tonic.
	(Keyboard) (*)	For each note, this lets you adjust the pitch in steps of one cent (1/100 semitone) relative to the equal-tempered pitch.
	PC (Rx Program Change)	Specifies whether Program Change messages will be received (ON) or not (OFF).
MIDI	BS (Rx Bank Select)	Specifies whether Bank Select messages will be received (ON) or not (OFF).
	BEND (Rx Pitch Bend)	Specify whether Pitch Bend messages will be received (ON), or not (OFF).
	PAFT (Rx Poly Key Press)	Specify whether Polyphonic Key Pressure messages will be received (ON), or not (OFF).
	CAFT (Rx Ch Press)	Specify whether Channel Pressure messages will be received (ON), or not (OFF).
	MOD (Rx Modulation)	Specify whether Modulation messages will be received (ON), or not (OFF).
	VOL (Rx Volume)	Specify whether Volume messages will be received (ON), or not (OFF).
	PAN (Rx Pan)	Specify whether Pan messages will be received (ON), or not (OFF).
	EXP (Rx Expression)	Specify whether Expression messages will be received (ON), or not (OFF).
	HOLD (Rx Hold-1)	Specify whether Hold 1 messages will be received (ON), or not (OFF).
	VELO CRV (Velo Crv Type)	Velocity Curve selects for each MIDI channel one of the four Velocity Curve types that best matches the touch of the connected MIDI keyboard. Set this to "OFF" if you are using the MIDI keyboard's own velocity curve.

(*): Not shown in the PART VIEW -ALL- screen.

* Depending on the sound, some of the part parameters will have no effect.

Ext part

Parameter	Explanation
Level	Specifies the volume of the part. This is used mainly to adjust the volume balance between parts.
Cho Send Level	Specifies the depth of chorus. Set this to 0 if you don't want to apply chorus.
Rev Send Level	Specifies the depth of reverb. Set this to 0 if you don't want to apply reverb.

Saving a Studio Set

Edits you make to a Studio Set are temporary; they will be lost when you turn off the unit or select another Studio Set. If you want to keep an edited Studio Set, you must save it.

NOTE

When you execute the Write operation, the existing data at the write destination will be overwritten.

1. From the top screen or the STUDIO SET EDIT screen, hold down the [SHIFT] button and press the [EDIT] button.

The WRITE MENU screen will appear.



2. Choose "STUDIO SET WRITE" and press the [ENTER] button.
3. Assign a name for the Studio Set.
For details on how to assign a name, refer to "Assigning a Name" (p. 29).
4. Press the [ENTER] button.
5. Use the value dial or the [DEC] [INC] buttons to select the desired save destination.
6. Press the [ENTER] button.
A message will ask "Are you sure?"
7. To execute, choose "OK" and press the [ENTER] button.

MEMO

If you decide to cancel without saving, press the [EXIT] button.

NOTE

Never turn off the unit while settings are being saved.

Panning the Sound with Depth (MOTIONAL SURROUND Screen)

In addition to the left/right panning of each sound, the INTEGRA-7 lets you specify its depth in the sound field.

In the MOTIONAL SURROUND screen you can visually specify the left/right panning and depth of each sound.

1. Press the [MOTIONAL SURROUND] button.

Motional Surround will turn on, and the MOTIONAL SURROUND screen will appear.



2. Use the cursor buttons to specify the position (left/right and depth) of each instrument.

You can use the PART [◀] [▶] buttons to switch the part you're editing.

MEMO

- If you want to turn Motional Surround off, press the [MOTIONAL SURROUND] button once again in the Motional Surround screen.
- If you want to return to the previous screen but leave Motional Surround turned on, press the [EXIT] button.
- The [MOTIONAL SURROUND] button's indicator shows whether Motional Surround is on (lit) or off (unlit).
- By holding down the [SHIFT] button and pressing the [MOTIONAL SURROUND] button, you can access the Motional Surround screen without changing the Motional Surround on/off setting.

* Motional Surround and reverb/chorus cannot be applied at the same time.

* When you turn Motional Surround on, reverb/chorus will turn off.

Editing the Motional Surround Settings

Here's how to turn Motional Surround on/off and specify the size of the room.

1. In the MOTIONAL SURROUND screen, press the [ENTER] button.

MOTIONAL SURROUND EDIT screen will appear.

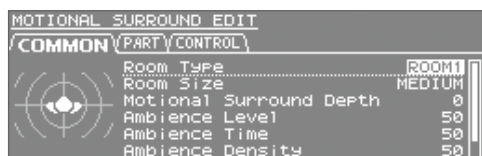

2. Use the cursor buttons to select the item you want to edit, and use the value dial to edit the value.

You can use the cursor [◀] [▶] buttons to switch tabs.

Tab	Parameter	Explanation
COMMON	These are overall settings for Motional Surround.	
	Room Type	Specifies the room type.
	Room Size	Specifies the room size.
	Motional Surround Depth	Specifies the depth of the Motional Surround effect.
	Ambience Level	Specifies the volume of ambience.
	Ambience Time	Specifies the duration of ambience.
	Ambience Density	Specifies the density of ambience.
	Ambience HF Damp	Specifies the frequency at which the high range of the ambience will be cut.
PART	These numerically specify the position of each part's instrument. You can also use MIDI control changes to control the values of these parameters (except for Width).	
	L-R	Specifies the left/right position. Control change number • 1-16 Part : CC12 • Ext Part : CC28
	F-B	Specifies the front/rear (back) position. Control change number • 1-16 Part : CC13 • Ext Part : CC29
	Width	Specifies the width of the positioned sound.
	Ambience Send Level	Specifies the send level to ambience Control change number • 1-16 Part : CC14 • Ext Part : CC30
CONTROL	Ext Part Control Ch	Specifies the MIDI channel used when controlling the front/back/left/right position and ambience send level of an Ext part via MIDI.

MEMO

For details on the parameters, refer to "Parameter Guide PDF"

Turning Effects On/Off

1. In the top screen, press the [EFFECTS] button.

The EFFECTS ROUTING screen will appear.

When Motional Surround is "off"

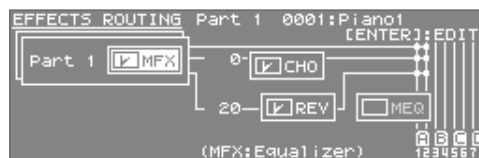

When Motional Surround is "on"

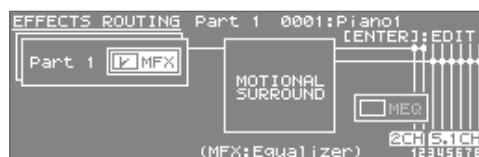

2. Use the cursor buttons to select the effect that you want to turn on/off.
3. Use [DEC] [INC] button to turn each effect on/off.

Editing the Effects of a Studio Set (EFFECTS ROUTING Screen)

Here's how to edit a studio set's effects.

1. In the top screen, press the [EFFECTS] button.

The EFFECTS ROUTING screen will appear.

When Motional Surround is "off"



When Motional Surround is "on"

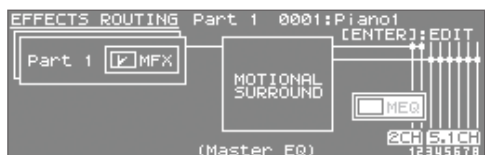

2. Move the cursor to the effect that you want to edit, and press the [ENTER] button.
3. Use the cursor buttons to select the setting you want to edit, and use the value dial to edit its value.

Editing the CHORUS Settings

To edit Chorus settings, access the Chorus parameter screen.

* Chorus will not be available when Motional Surround is on.

1. Access the EFFECTS SWITCH screen or the EFFECTS ROUTING screen when the Motional Surround function is "OFF;" move the cursor to "CHORUS," and press the [ENTER] button.

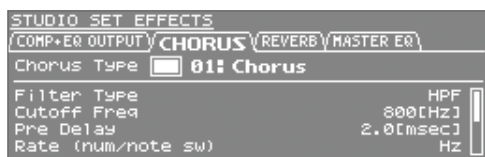

2. Use the cursor buttons to select the setting you want to edit, and use the value dial to edit its value.

Editing the REVERB Settings

To edit Reverb settings, access the Reverb parameter screen.

* Reverb will not be available when Motional Surround is on.

1. Access the EFFECTS SWITCH screen or the EFFECTS ROUTING screen when the Motional Surround function is "OFF;" move the cursor to "REVERB," and press the [ENTER] button.



2. Use the cursor buttons to select the setting that you want to edit, and use the value dial to edit its value.

Adjusting the Overall Tone of the Audio Output (MASTER EQ)

Here's how to make final adjustments to the overall tone of INTEGRA-7's audio output (OUTPUT A (MIX) jacks and PHONES jack).

1. From the EFFECTS ROUTING screen, move the cursor to "MEQ (MASTER EQ)" and press the [ENTER] button.

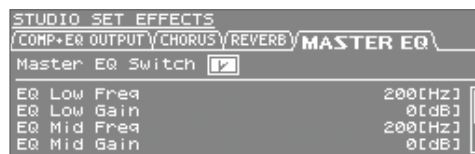

2. Use the cursor buttons to select the setting that you want to edit, and use the value dial to edit its value.

Initializing a Part

This operation will initialize the part settings of the current part.

1. From the top screen or the STUDIO SET EDIT screen, press the [MENU] button.
2. Choose "PART INIT" and press the [ENTER] button.

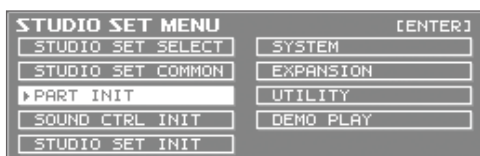

A message will ask "Are you sure?"

3. To initialize, choose "OK" and press the [ENTER] button.

Initializing the Sound Controls

This operation will initialize the following offset parameters that affect how each part sounds.

- Cutoff Offset
- Resonance Offset
- Attack Offset
- Decay Offset
- Release Offset
- Vibrato Rate
- Vibrato Depth
- Vibrato Delay

1. From the top screen or the STUDIO SET EDIT screen, press the [MENU] button.
2. Choose "SOUND CTRL INIT" and press the [ENTER] button.

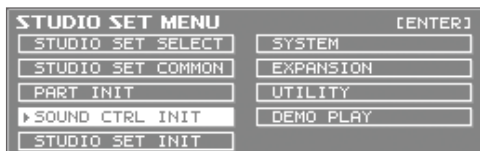

A message will ask "Are you sure?"

3. To initialize, choose "OK" and press the [ENTER] button.

Initializing a Studio Set

Here's how to initialize the currently selected Studio Set.

1. From the top screen or the STUDIO SET EDIT screen, press the [MENU] button.
2. Choose "STUDIO SET INIT" and press the [ENTER] button.



A message will ask "Are you sure?"

3. To initialize, choose "OK" and press the [ENTER] button.

Editing a Tone

Editing the Tones Assigned to a Part

Here's how to edit the sound of each part.

1. Select the part that you want to edit.
2. Press the [EDIT] button.

The tone edit screen will differ depending on the type of tone that's selected for the part.

MEMO

For details on the tone parameters, refer to "Parameter Guide PDF."

SuperNATURAL Acoustic Tone (SN-A)

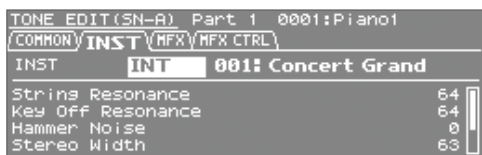

Tab	Explanation
COMMON	Settings that apply to the entire tone.
INST	Settings for the INST assigned to the tone. These are detailed settings for the INST that's assigned.
MFX	Settings for the multi-effect.
MFX CTRL	Settings for controlling MFX via MIDI.

SuperNATURAL Synth Tone (SN-S)

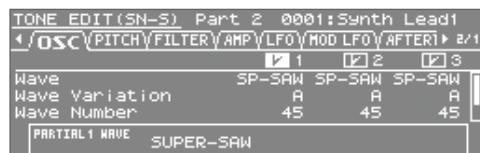
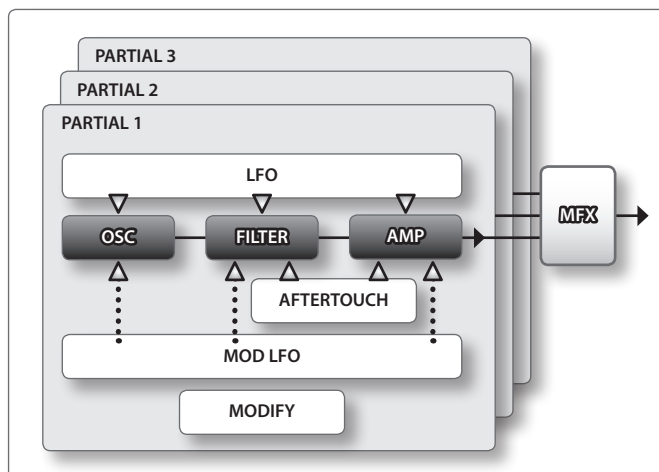

Tab	Explanation
COMMON	Settings that apply to the entire tone.
OSC	Settings for the waveform that is the basis of the tone.
PITCH	Settings related to pitch.
FILTER	Settings related to the filter.
AMP	Settings related to the volume.
LFO	Settings for the LFO that modulates the sound.
MOD LFO	Settings for the modulation applied to the sound.
AFTERTOUCH	Settings related to aftertouch.
MISC	Settings for envelopes and portamento time control.
MFX	Settings for the multi-effect.
MFX CTRL	Settings for controlling MFX via MIDI.

SuperNATURAL Drum Kit (SN-D)

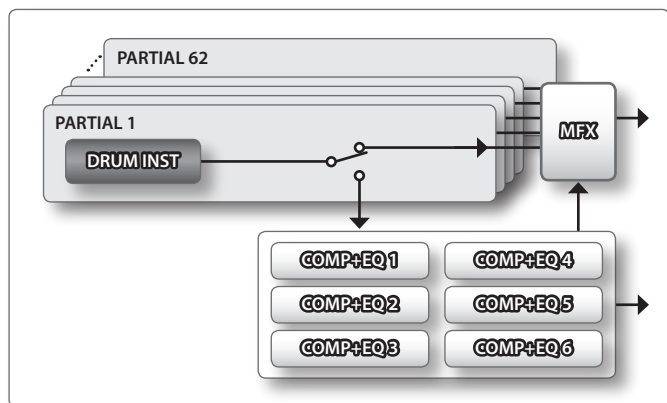

```
TONE EDIT(SN-D) Part 3 0001:Drum Kit1
< /DRUM INST VCOMP VEQ V MFX V MFX CTRL 2/ 5
CURRENT PARTIAL
36 (C 2) INT 001: Studio Kick
Level ..... 100
Pan ..... 0
Chorus Send Level ..... 0
Reverb Send Level ..... 25
```

Tab	Explanation
COMMON	Settings that apply to the entire tone.
DRUM INST	Instrument settings for each partial.
COMP	Settings for the drum part compressor.
EQ	Settings for the drum part equalizer.
MFX	Settings for the multi-effect.
MFX CTRL	Settings for controlling MFX via MIDI.

MEMO

If a note-on message is received, the partial number you're editing will change.

PCM Synth Tone (PCMS)

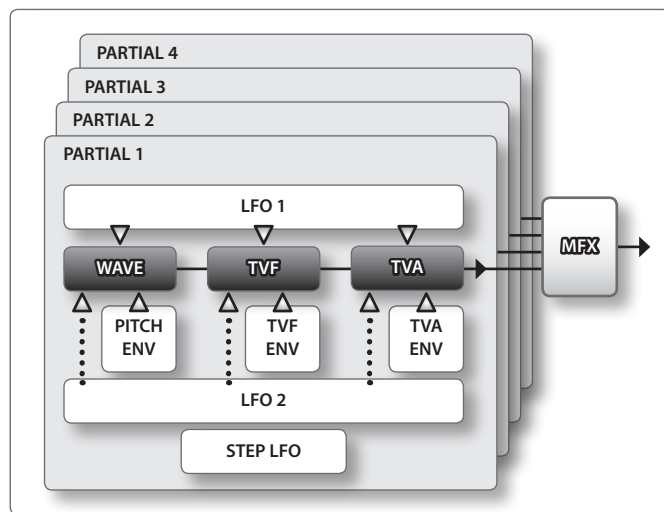

```
TONE EDIT(PCMS) Part 4 0001:Piano1
< /WAVE V PMT V PITCH V PITCH ENV V TVF V TVF ENV V TVA V TVA ENV V Ti 2/20
Wave Group ..... INT INT INT INT
Wave No. L (Mono) ..... 19 27 14 OFF
Wave No. R ..... OFF OFF OFF OFF
PARTIAL1 INT
L 19:Ac Piano1 A R 0:OFF
```

Tab	Explanation
COMMON	Settings that apply to the entire tone.
WAVE	Settings for the waveform that is the basis of the tone.
PMT (Partial Mix Table)	Settings for how partials are combined, and for key range.
PITCH	Settings related to pitch.
PITCH ENV	Settings for the pitch envelope.
TVF	Settings related to the filter.
TVF ENV	Settings for the TVF envelope.
TVA	Settings related to volume.
TVA ENV	Settings for the TVA envelope.
OUTPUT	Settings related to output.
LFO 1	Settings for the LFO that modulates the sound.
LFO 2	
STEP LFO	Settings that specify how steps 1–16 will modulate the sound.
CTRL	Settings related to controllers.
MTRX CTRL 1	Settings related to matrix controls 1–4.
MTRX CTRL 2	
MTRX CTRL 3	
MTRX CTRL 4	
MFX	Settings for the multi-effect.
MFX CTRL	Settings for controlling MFX via MIDI.

MEMO

You can't edit the sounds of the GM2 bank or the ExPCM bank.

PCM Drum Kit (PCMD)

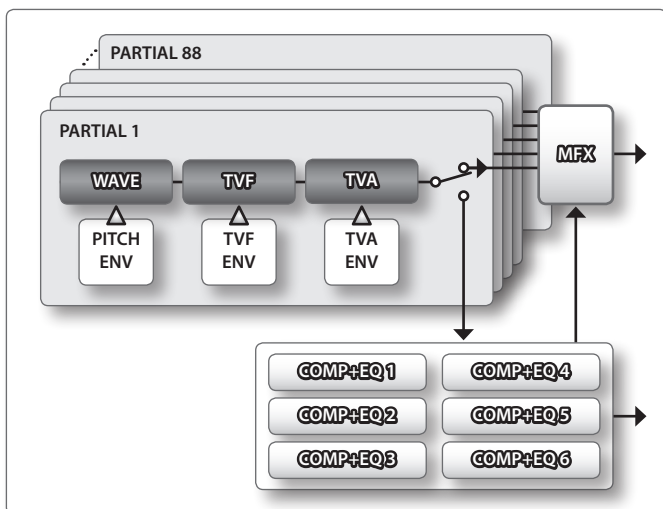

TONE EDIT(PCMD) Part 5 0001:Drum Kit1				
WAVE	WMT	PITCH	PITCH ENV	TVF
60(C 4)	<input checked="" type="checkbox"/> 1 <input type="checkbox"/> 2 <input type="checkbox"/> 3 <input type="checkbox"/> 4			
Wave Group	INT	INT	INT	INT
Wave No. L (Mono)	846	OFF	OFF	OFF
Wave No. R	OFF	OFF	OFF	OFF
PARTIAL1 INT				
L 846:C9a Mute Hi	R	0:OFF		

Tab	Explanation
COMMON	Settings that apply to the entire tone.
WAVE	Settings for the waveform that is the basis of the tone.
WMT (Wave Mix Table)	Make settings for velocity-switching between tones..
PITCH	Settings related to pitch.
PITCH ENV	Settings for the pitch envelope.
TVF	Settings related to the filter.
TVF ENV	Settings for the TVF envelope.
TVA	Settings related to volume.
TVA ENV	Settings for the TVA envelope.
OUTPUT	Settings related to output.
COMP	Settings for the Drum Comp + EQ Assign part compressor.
EQ	Settings for the Drum Comp + EQ Assign part equalizer.
MFX	Settings for the multi-effect.
MFX CTRL	Settings for controlling MFX via MIDI.

MEMO

- If a note-on message is received, the partial number you're editing will change.
- You can't edit the sounds of the GM2 bank or the ExPCM bank.

Saving a Tone/Drum Kit

Edits you make to a Tone/Drum Kit are temporary; they will be lost when you turn off the unit or select another Tone/Drum Kit. If you want to keep an edited Tone/Drum Kit, you must save it.

NOTE

When you execute the Write operation, the existing data at the write destination will be overwritten.

1. In the TONE EDIT screen, hold down the [SHIFT] button and press the [EDIT] button.



2. Assign a name to the tone/drum kit.

For details on assigning a name, refer to "Assigning a Name" (p. 29).

3. Press the [ENTER] button.

4. Move the cursor to the save destination, and use the value dial or the [DEC] [INC] buttons to specify the save destination.

5. Press the [ENTER] button.

A message will ask "Are you sure?"

6. To execute, select "OK" and press the [ENTER] button.

MEMO

If you decide to cancel without saving, press the [EXIT] button.

NOTE

Never turn off the unit while data is being written to memory.

Editing the Effects of a Tone

Here's how to edit the MFX settings or the settings of the compressor and equalizer used by the drum part.

1. In the top screen, press the [EFFECTS] button.

The EFFECTS ROUTING screen will appear.

When Motional Surround is "off"

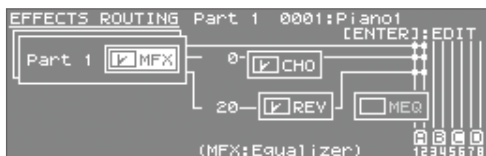

When Motional Surround is "on"

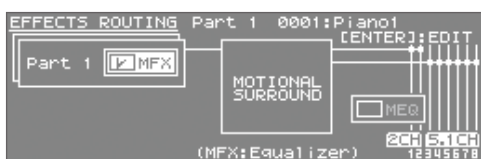

2. Move the cursor to the effect that you want to edit, and press the [ENTER] button.
3. Use the cursor buttons to select an item, and use the value dial to edit its value.

Editing the MFX (Multi-Effect) Settings

Here's how to make detailed settings for the multi-effect.

MFX settings are handled as part of the tone; your edits are saved as a user tone.

1. In the EFFECTS ROUTING screen, move the cursor to "MFX" and press the [ENTER] button.

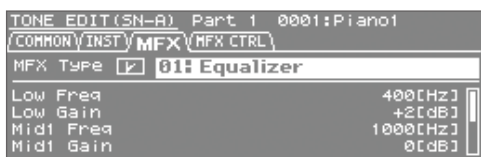

2. Use the cursor buttons to select an item, and use the value dial to edit its value.

Editing the COMP (Compressor) and EQ (Equalizer) Settings

Here's how to make compressor and equalizer settings for the drum kit of a Drum COMP + EQ Assign part.

There are six compressor/equalizer sets; for each instrument (DRUM INST) in the drum kit, you can select the compressor/equalizer set that will be used.

1. Use the PART [◀] [▶] buttons to select the part that is specified as the Drum Comp+EQ Assign part.

"COMP+EQ" will appear in the screen.



MEMO

The Drum COMP + EQ Assign part to which the compressor and equalizer are applied can be specified in the "GENERAL" tab (p.32) of the Studio Set Common screen.

2. In the EFFECTS ROUTING screen, move the cursor to "Comp+EQ" and press the [ENTER] button.

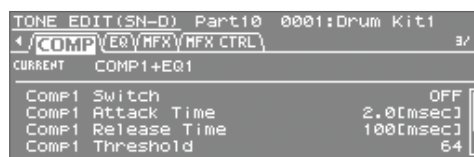

3. Use the cursor buttons to select an item, and use the value dial to edit its value.

MEMO

In the EFFECTS ROUTING screen, you can place the cursor at the location shown in the illustration and press the [ENTER] button to access the COMP + EQ output setting screen.

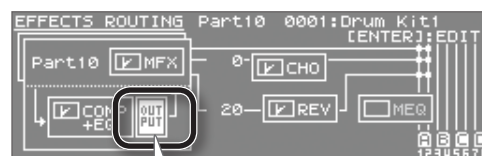

Settings for COMP + EQ output can be saved as parameters of the studio set.

Initializing a Tone

Here's how you can initialize the settings of the current tone.

1. Press the [EDIT] button.
The TONE EDIT screen will appear.
2. Press the [MENU] button.
3. Choose "TONE INIT" and press the [ENTER] button.

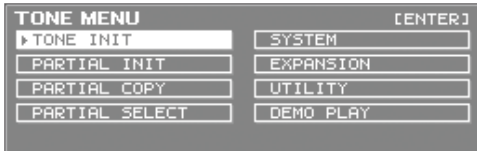

A message will ask "Are you sure?"

4. To initialize, choose "OK" and press the [ENTER] button.
If you decide to cancel, press the [EXIT] button.
When the initialization has been completed, press the [MENU] button to return to the previous screen.

Initializing a Partial

Here's how to initialize the partials of a SuperNATURAL Synth Tone, SuperNATURAL Drum Kit, PCM Synth Tone, or PCM Drum Kit.

1. Press the [EDIT] button.
The TONE EDIT screen will appear.
2. Press the [MENU] button.
3. Choose "PARTIAL INIT" and press the [ENTER] button.

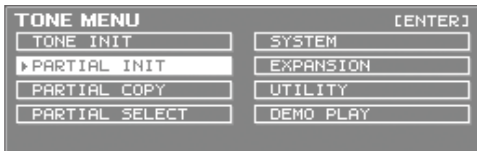

4. Select the partial that you want to initialize.
5. To initialize, choose "OK" and press the [ENTER] button.
If you decide to cancel, press the [EXIT] button.
When the initialization has been completed, press the [MENU] button to return to the previous screen.

Copying a Partial

Here's how to copy the partial settings of a SuperNATURAL Synth Tone, SuperNATURAL Drum Kit, PCM Synth Tone, or PCM Drum Kit.

1. Press the [EDIT] button.
The TONE EDIT screen will appear.
2. Press the [MENU] button.
3. Choose "PARTIAL COPY" and press the [ENTER] button.

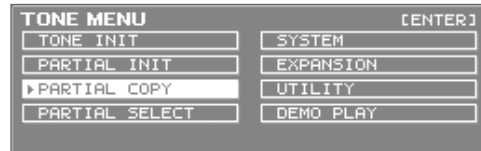

4. Select the copy-source partial and the copy-destination partial.
5. To execute, choose "OK" and press the [ENTER] button.

Selecting the Partial to Edit

Here's how to select the partials of a SuperNATURAL Synth Tone, SuperNATURAL Drum Kit, PCM Synth Tone, or PCM Drum Kit.

1. Press the [EDIT] button.
The TONE EDIT screen will appear.
2. Press the [MENU] button.
3. Choose "PARTIAL SELECT" and press the [ENTER] button.

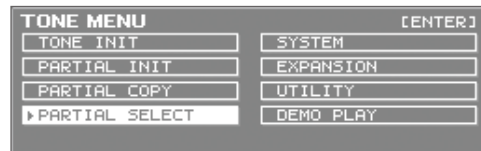

4. Select the partial that you want to edit.
5. Turn the value dial or use [DEC] [INC] buttons to switch the partial/wave you're editing on/off.
* For a SuperNATURAL drum kit, only one partial can be selected.
* You can't switch all partials off.

Using the INTEGRA-7 with Your Computer

If you use a commercially available USB cable to connect the USB COMPUTER port on the INTEGRA-7's rear panel to your computer's USB connector, audio or MIDI data played by your MIDI software (DAW software) can be sounded by the INTEGRA-7.

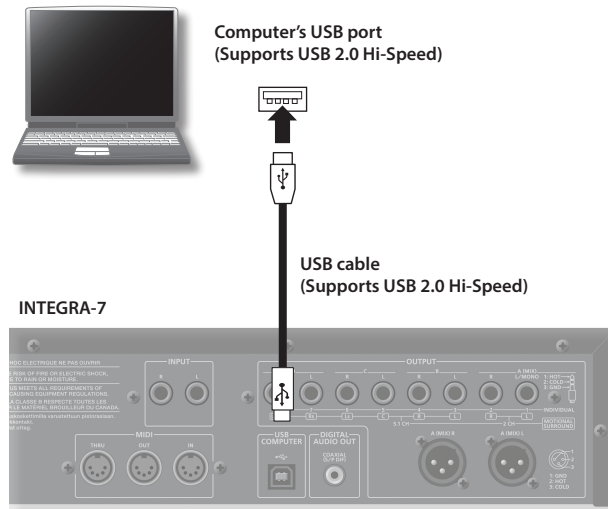

For details on operating requirements, refer to the Roland website.

<https://www.roland.com/global/support/>

NOTE

- For some models of computer, the system might not operate correctly. Refer to the Roland website for the operating systems that are supported.
- Before you make connections to other equipment, turn down the volume and turn off the power off on all equipment in order to prevent malfunction and/or speaker damage.
- A USB cable is not included. To purchase one, please contact the dealer where you purchased the INTEGRA-7.
- Use a USB cable that supports USB 2.0 Hi-Speed.
- Use a computer that supports USB 2.0 Hi-Speed.
- Switch on the INTEGRA-7 before you start up the DAW software on your computer. Do not switch the INTEGRA-7 on/off while your DAW software is running.

What is the USB driver?

The USB driver is software that transfers data between the INTEGRA-7 and the application (e.g., DAW software) on your computer when the INTEGRA-7 is connected via USB to your computer.

The USB driver sends data from your application to the INTEGRA-7, and data from the INTEGRA-7 to your application.

USB MIDI (p. 45)

You'll be able to use the INTEGRA-7 as a MIDI interface with your DAW software, and use the INTEGRA-7's sound generator to play performance data (MIDI data) that's played back by your DAW software.

USB audio (p. 46)

If you want to use USB audio, you'll need to use the VENDER driver (p. 44).

Settings for INTEGRA-7 → computer

If the INTEGRA-7 is connected via a USB cable to the application (e.g., DAW software) on your computer, the same sound as from the INTEGRA-7's MAIN OUT can be recorded into your computer.

Settings for computer → INTEGRA-7

Sound from your computer can be played from the audio system connected to the INTEGRA-7's OUTPUT jacks.

If the Motional Surround function is on, the sound from your computer can also be positioned in the front/rear and left/right directions.

USB Driver

Here's how to switch between the dedicated INTEGRA-7 USB driver and the generic driver provided by the operating system.

If you want to use USB audio, you'll need to use the VENDER driver.

1. In the MENU screen, choose "SYSTEM" and press the [ENTER] button.
2. Choose "SETUP" tab and press the [ENTER] button.
3. Specify the USB Driver that you want to use.

When you change this setting, a confirmation message will appear.

Driver	Explanation
VENDER (MIDI+AUDIO)	The dedicated INTEGRA-7 driver provided by Roland will be used. MIDI and audio will be available.
GENERIC (MIDI only)	The generic driver provided by the operating system will be used. Only MIDI will be available.

MEMO

This setting will take effect after you've carried out a System Write, and you've turned the unit off, then back on again.

4. Choose "WRITE" and press the [ENTER] button to save the setting.
5. Turn the unit off, then on again.

Connecting the INTEGRA-7 to Your Computer

1. Install the USB driver on your computer.

If you want to use the INTEGRA-7's USB audio functionality, change the USB Driver setting to VENDER and then install the driver. You can download the driver from the Roland website.

Roland website

<https://www.roland.com/global/support/>

The procedure for installing the driver will differ depending on your system. Before you proceed, you should carefully read the "Readme" file that was extracted along with the installer.

2. Use a USB cable (sold separately) to connect the INTEGRA-7 to your computer.

USB MIDI

If you connect your computer and MIDI keyboard to the INTEGRA-7 as shown in the illustration and turn the USB-MIDI Thru ON, you'll be able to use the INTEGRA-7 as a MIDI interface.

This is convenient when you want to use a MIDI keyboard with DAW software on your computer to create song data.

For details about settings on your computer, refer to the owner's manual of the software you're using.

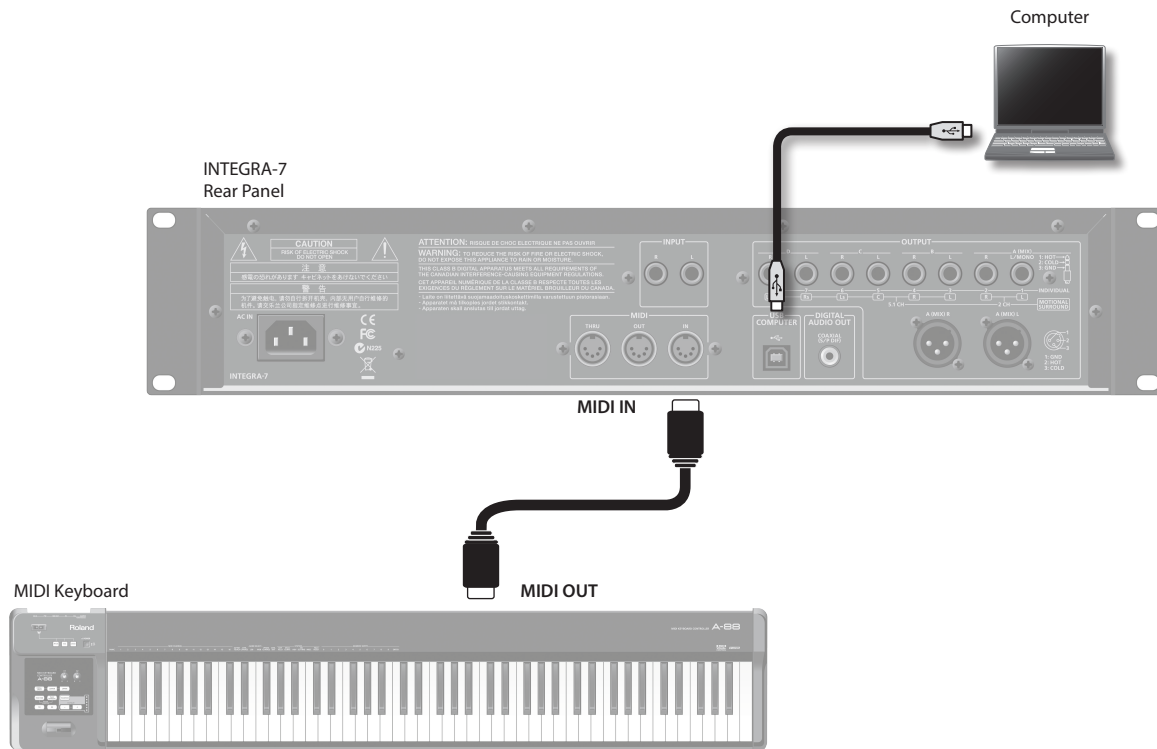

If you want to play the sound generator of the INTEGRA-7 directly from your MIDI keyboard, turn the USB-MIDI Thru OFF.

MIDI Signal Flow

USB-MIDI Thru=OFF

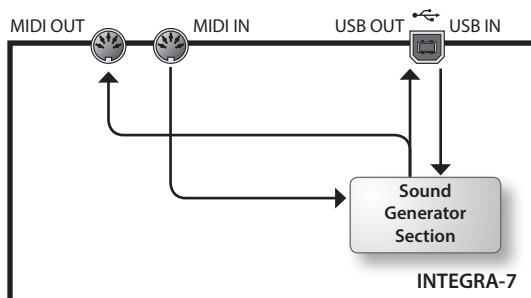

USB-MIDI Thru=ON

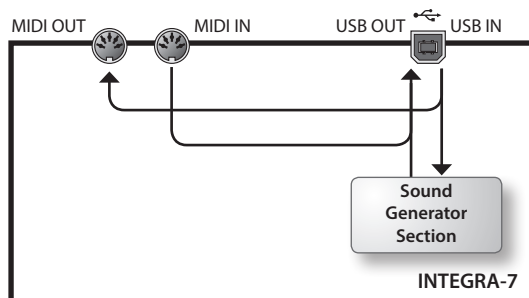

Specifying the Output Destination of the Incoming Messages

Here's how to specify whether the MIDI messages received at MIDI IN will be retransmitted without change to computer (the "ON" setting), or will not be transmitted (the "OFF" setting).

1. Press the [MENU] button.
2. Choose "SYSTEM" and press the [ENTER] button.
3. In the "MIDI" tab, choose "USB-MIDI Thru" and specify the ON/OFF setting.
4. Hold down the [SHIFT] button and press the [EDIT] button to save the setting.

USB AUDIO

Sound played back by your computer can be output from the INTEGRA-7.

MEMO

If you want to use the INTEGRA-7's USB audio functionality, change the USB Driver setting to VENDER and then install the driver. You can download the driver from the Roland website.

Roland website

<https://www.roland.com/global/support/>

The procedure for installing the driver will differ depending on your system. Before you proceed, you should carefully read the "Readme" file that was extracted along with the installer.

Audio Signal Flow

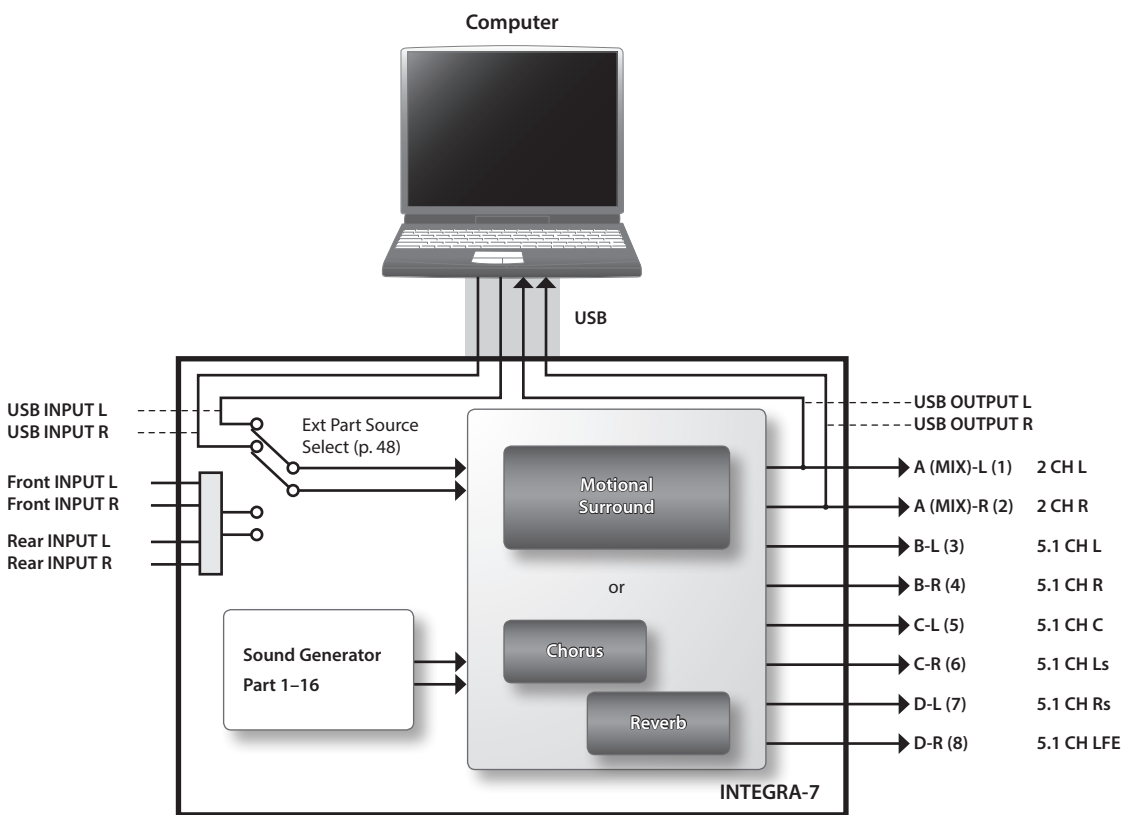

Specifying the Sampling Rate for USB Audio

Here's how to specify the sampling rate of the INTEGRA-7. If you're using software, you'll also need to restart your software. The USB Audio Sampling Rate must be set to match the sampling rate of the software you're using.

1. In the MENU screen, choose "SYSTEM" and press the [ENTER] button.
2. In the "SOUND" tab, choose "Sampling Rate" and change the setting.
3. Change the "Sampling Rate" setting.

MEMO

If you want to save the setting, hold down the [SHIFT] button in the system setting screen and press the [EDIT] button.

The INTEGRA-7's audio format

Sampling rate	44.1, 48, 96 kHz
Bit depth	24-bit (fixed)
Number of channels	2 channels (stereo)

Applying Motional Surround to Sounds of an External Device

Connection Example

You can assign the sound of the external input as the Ext part, and apply Motional Surround to it.

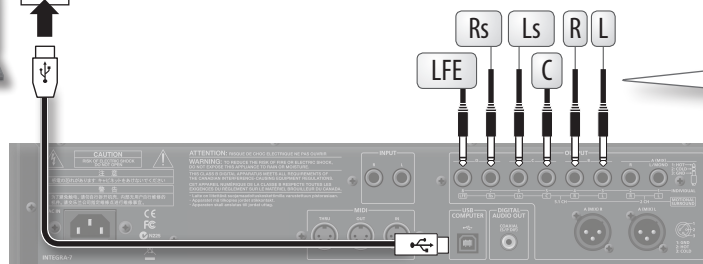
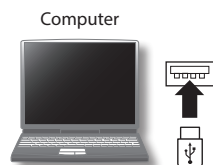
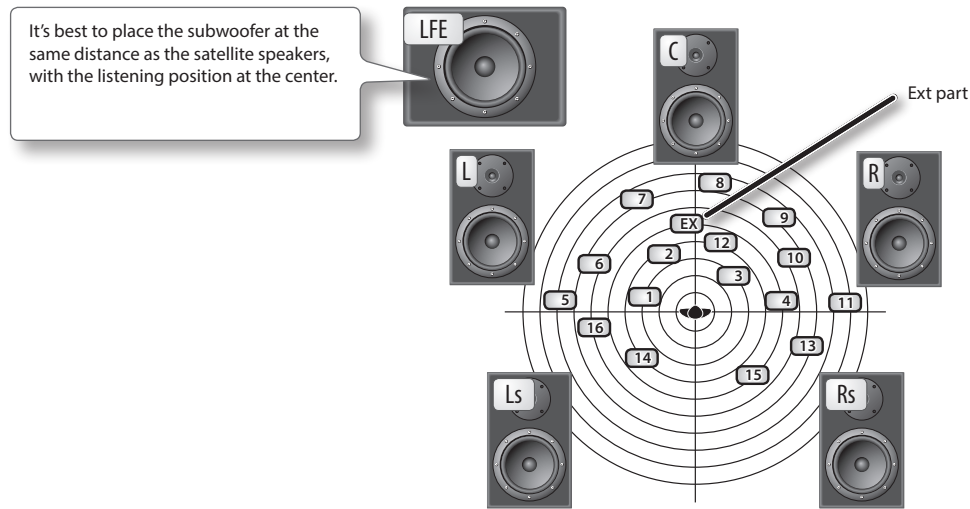

Jack name	Explanation
L	Front left output
R	Front right output
C	Front center output
Ls	Rear left output
Rs	Rear right output
LFE	Subwoofer output

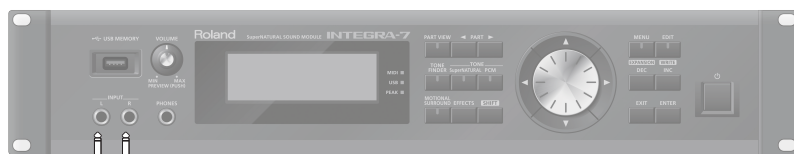

MIDI Keyboard/Synthesizer



MEMO

- In order to use Motional Surround, you must turn Motional Surround on (p. 34).
- If you want to apply Motional Surround to the sound of the external input, set the "Ext Part Source Sel" parameter (p. 48) to "Input."
- If you want to apply Motional Surround to your PC's sound, set the "Ext Part Source Sel" parameter (p. 48) to "USB."
- Depending on the equipment you've connected and the sound that is being input, it may be difficult to obtain the Motional Surround effect.

Overall Settings

System Settings

Here you can make overall settings that apply to the entire INTEGRA-7, such as those for tuning and MIDI message reception.

1. In the MENU screen, choose "SYSTEM" and press the [ENTER] button

The SYSTEM screen will appear.

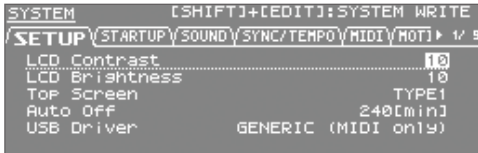

2. Select the item whose settings you want to edit.
3. Select the parameter that you want to edit, and edit its value.

Saving the System Settings

System settings will return to their previous state when you turn off the unit. If you want these settings to be retained even after the unit is turned off, you must save the system settings.

1. In the SYSTEM screen, hold down the [SHIFT] button and press the [EDIT] button.

A message will indicate "Completed!" and the settings will be saved.

NOTE

Never turn off the unit while data is being saved.

System Parameter

The operations of the system parameters are explained below, organized according to the structure of the parameters.

Setup Settings (SETUP)

Parameter	Value	Explanation
LCD Contrast	1–20	Adjusts the contrast of the display.
LCD Brightness	1–20	Adjusts the brightness of the display. The brightness will increase as the value is raised.
Top Screen	TYPE1, TYPE2	TYPE1: A screen that shows the tone of the current part in large characters TYPE2: A screen that shows the studio set and tones * You can also switch this by pressing [SHIFT] + [ENTER] in the top screen.
Auto Off	OFF, 30 [min], 240 [min]	Specifies whether the unit will turn off automatically after a certain time has elapsed. (p. 55) If you don't want the unit to turn off automatically, choose "OFF" setting.
USB Driver	VENDER (MIDI+AUDIO), GENERIC (MIDI Only)	Specifies whether the INTEGRA-7 will use the dedicated driver provided by Roland (VENDER) or the standard driver provided by the operating system (GENERIC) (p. 44). If you choose GENERIC, USB operation is limited to MIDI. * This setting will take effect after you save the settings and turn the unit off, then on again.

Startup Settings (STARTUP)

Parameter	Value	Explanation
Startup Studio Set	LAST-SET, (Studio Set number)	Specifies the studio set that will be loaded when the unit is turned on. If you want the most recently selected studio set to be loaded, choose "LAST-SET."
Startup Expansion SlotA–SlotD	OFF, (Sound Library name)	Specifies the sound library that will be loaded into each RAM slot when the unit is turned on.

Volume and Pitch Settings (SOUND)

Parameter	Value	Explanation
Master Level	0–127	Specifies the overall volume of the INTEGRA-7.
Master Tune	415.3–466.2 Hz	Specifies the overall tuning. The displayed value is the frequency of the A4 note (middle "A").
Output Gain	-12–+12 dB	Adjusts the output gain of the analog output and digital output.
Master Key Shift	-24–+24	Transposes the overall pitch in semitone steps.
Sampling Rate	44.1, 48, 96 kHz	Specifies the audio sampling rate.
Ext Part Source Select	USB AUDIO, INPUT	Selects the input source that will be assigned to the Ext part.

Synchronization Settings (SYNC/TEMPO)

Parameter	Value	Explanation
Sync Mode	MASTER, SLAVE	MASTER: Choose this setting when using the INTEGRA-7 by itself. SLAVE: Choose this setting if you want the INTEGRA-7 to operate in synchronization with the MIDI clock of an external device.
Clock Source	MIDI, USB	If the Sync Mode is set to "SLAVE," you can specify whether the INTEGRA-7 will synchronize with clock received at the MIDI IN or with clock received at the USB port.
System Tempo	20–250	Specifies the system tempo. * If the Sync Mode is "SLAVE," this tempo value is ignored because the INTEGRA-7 will synchronize to clock data received from an external MIDI device.
Tempo Assign Source	SYSTEM, STUDIO SET	Specifies whether the tempo will follow the system setting (System Tempo) or the tempo of each studio set (Studio Set Tempo).

MIDI Settings (MIDI)

Parameter	Value	Explanation
Device ID	17–32	When transmitting and receiving system exclusive messages, the device ID numbers of both devices must match.
Studio Set Control Channel	1–16, OFF	Specifies the MIDI receive channel on which MIDI messages (program change/bank select) from an external MIDI device will be received by the INTEGRA-7 to switch studio sets. Choose “OFF” setting if you don’t want studio sets to be switched from a connected MIDI device.
USB-MIDI Thru	OFF, ON	Specifies whether MIDI messages received via the USB COMPUTER port/MIDI IN connector will be re-transmitted from the MIDI OUT connector/USB COMPUTER port (ON) or not be re-transmitted (OFF) (p. 45).
Tx Edit Data	OFF, ON	When you edit tone or studio set settings, this specifies whether your edits will be transmitted as system exclusive messages (ON) or not be transmitted (OFF).
Rx Program Change	OFF, ON	Specifies whether program change messages will be received (ON) or not be received (OFF).
Rx Bank Select	OFF, ON	Specifies whether bank select messages will be received (ON) or not be received (OFF).
Rx Exclusive	OFF, ON	Specifies whether system exclusive messages will be received (ON) or not be received (OFF).
Rx GM System On	OFF, ON	Specifies whether GM System On messages will be received (ON) or not be received (OFF).
Rx GM2 System On	OFF, ON	Specifies whether GM2 System On messages will be received (ON) or not be received (OFF).
Rx GS Reset	OFF, ON	Specifies whether GS Reset messages will be received (ON) or not be received (OFF).

Motional Surround Settings (MOTIONAL SURROUND)

Parameter	Value	Explanation
2CH Out Mode	SPEAKER, PHONES	Specifies whether the two-channel surround output will be processed appropriately for listening through speakers (SPEAKER) or headphones (PHONES).
5.1CH Center SP Switch	OFF, ON	Specifies whether sound will (ON) or will not (OFF) be output from the front center speaker of a 5.1 channel speaker system.
5.1CH Sub Woofer (LFE) Switch	OFF, ON	Specifies whether sound will (ON) or will not (OFF) be output from the subwoofer of a 5.1 channel speaker system.

Preview Settings (PREVIEW)

Parameter	Value	Explanation
Preview Mode	SINGLE, CHORD, PHRASE	SINGLE: The notes specified by Preview 1–4 Note Number will be sounded one at a time, consecutively. CHORD: The notes specified by Preview 1–4 Note Number will be sounded simultaneously. PHRASE: The phrase provided for the corresponding patch type (category) will be played.
Preview 1–4 Note Number	C-1–G9	Specify the pitches of the four notes that will be sounded if you set the Preview Mode to “SINGLE” or “CHORD.” * These settings are ignored if Preview Mode is set to “PHRASE.”
Preview 1–4 Velocity	OFF, 1–127	Specify the velocities of the four notes that will be sounded if you set the Preview Mode to “SINGLE” or “CHORD.” * These settings are ignored if Preview Mode is set to “PHRASE.”

Control Function Settings (CONTROL)

Parameter	Value	Explanation
System Control Src1–4	OFF, CC01–31, 33–95, PITCH BEND, AFTER-TOUCH	Specify the MIDI messages that will be used as system controls. System Control settings allow you to specify MIDI messages that will apply in common to the entire INTEGRA-7, and can be used for controlling volume, tone, etc. You can assign up to four MIDI messages for this type of control. If you want to make assignments for realtime control of the sound and effects for each tone independently, use “matrix control” or “multi-effect control.” For details, refer to the “Parameter Guide PDF.”
Control Source Select	SYSTEM, STUDIO SET	SYSTEM: “System Control Src 1–4” will be used for tone control. STUDIO SET: Tone Control Src 1–4 (p. 32) of the Studio Set will be used for tone control.

Viewing the System Version

Shows the INTEGRA-7’s software version.

1. In the MENU screen, choose “SYSTEM” and press the [ENTER] button.

The SYSTEM screen will appear.

2. Use the cursor [◀] [▶] buttons to select the “VERSION” tab.



Convenient Functions

Basic Procedure for Utility Operations

1. In the MENU screen, choose "UTILITY" and press the [ENTER] button.

The UTILITY screen will appear.



2. Select the function that you want to execute, and press the [ENTER] button.

Function	Explanation	Page
BACKUP	Saves (backs up) all settings of the INTEGRA-7 to a USB flash drive.	p. 52
RESTORE	Restores data from a backup on a USB flash drive into the INTEGRA-7.	p. 53
EXPORT	Writes sound data of the INTEGRA-7 to a USB flash drive.	p. 51
IMPORT	Loads previously exported data from a USB flash drive into the INTEGRA-7.	p. 51
FACTORY RESET	Returns the INTEGRA-7 to its factory-set state.	p. 55
FORMAT USB MEMORY	Initializes the USB flash drive.	p. 50
BULK DUMP	Sends the studio set and tone settings in the temporary area to an external MIDI device.	p. 54

Initializing a USB Flash Drive (FORMAT USB MEMORY)

This operation will initialize (format) a USB flash drive.

NOTE

When you execute this operation, all data saved on the USB flash drive will be lost. If the USB flash drive contains important data, back it up to your computer before initializing the USB flash drive.

1. In the UTILITY screen, choose "FORMAT USB MEMORY" and press the [ENTER] button.



2. To initialize, choose "OK" and press the [ENTER] button.

NOTE

Never turn off the unit while the formatting is in progress.

USB Flash Drive

The settings of the INTEGRA-7, sound data backups, and data for studio sets and tones can be exported to a USB flash drive (p. 27).



NOTE

- Never insert or remove a USB flash drive while this unit is on. Doing so may corrupt the unit's data or the data on the USB flash drive.
- Carefully insert the USB flash drive all the way in-until it is firmly in place.
- Use USB flash drive available from Roland. Proper operation cannot be guaranteed if other USB device is used.
- Don't connect anything other than a USB flash drive to the USB MEMORY connector.

Exporting/Importing Sound Data

From the studio sets and tones saved in the INTEGRA-7, you can select the desired items and export them to a USB flash drive.

You can also select the desired studio sets or tones from a file that was exported to a USB flash drive, and import them into the INTEGRA-7.

When you export a studio set, the tones used by that studio set will also be exported.

* Connect your USB flash drive to the USB MEMORY port before you export or import.

Exporting Sound Data (Export)

1. In the UTILITY screen, choose "EXPORT" and press the [ENTER] button.

The EXPORT screen will appear.

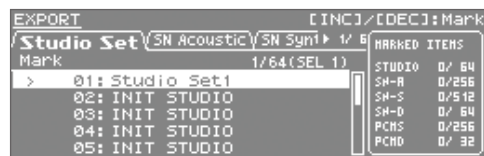

2. Mark the sound data that you want to export.

Select the desired studio set or tone, and press the [INC] button.

Pressing the [DEC] button will clear the mark.

You can use the tabs to switch between studio sets and different types of tones.

When you mark an item, an "*" will appear at the left of the Number/Name. A "+" symbol will automatically appear for the tones used by sound data marked with an "*" symbol. The "+" symbol cannot be directly erased.

3. Press the [ENTER] button.

4. Assign a name to the file that will be exported.

For details on assigning a name, refer to "Assigning a Name" (p. 29).

MEMO

The exported sound data will be saved together in a single file named *.SVD, located below /ROLAND/SOUND in the USB flash drive.

5. Press the [ENTER] button.

A message will ask "Are you sure?"

6. To export, choose "OK" and press the [ENTER] button.

NOTE

Never turn off the unit while the export operation is in progress.

Importing Sound Data (Import)

1. In the UTILITY screen, choose "IMPORT" and press the [ENTER] button.

The IMPORT screen will appear.

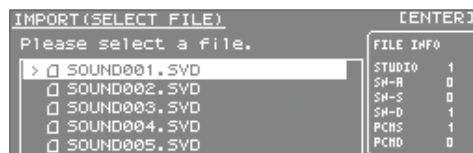

2. Select the data file from which you want to import, and press the [ENTER] button.

3. Select the sound data that you want to import.

Select the desired studio set or tone, and press the [INC] button.

Pressing the [DEC] button will clear the mark.

You can use the tabs to switch between studio sets and different types of tones.

When you mark an item, an "*" will appear at the left of the Number/Name. A "+" symbol will automatically appear for the tones used by sound data marked with an "*" symbol. The "+" symbol cannot be directly erased.

4. Press the [ENTER] button.

A screen will appear, allowing you to specify the destination for the import.

The names "INIT STUDIO," "INIT TONE," and "INIT KIT" will be used when assigning the import destinations; this occurs in order, starting with the lowest number.

NOTE

If you've edited a sound and have saved it with the name "INIT STUDIO," "INIT TONE," or "INIT KIT," it may be automatically selected as the destination for the import.

If you then execute the import, this data will be overwritten and lost. The lost sound data cannot be recovered.

Please save your important sound data using names other than "INIT STUDIO," "INIT TONE," and "INIT KIT."

5. If you want to change the destination of the import, clear the specified mark, and then select and mark the desired destination for the import.

For the import destination, select the same number of sound data items as you marked in step 3. (Importing is not possible if the number is insufficient.)

You cannot select more import destinations than the number of sound data items being imported.

6. Press the [ENTER] button.

A message will ask "Are you sure?"

7. To Import, choose "OK" and press the [ENTER] button.

NOTE

Never turn off the unit while the import is in progress.

Marking Multiple Items of Data

You can select multiple consecutive items of sound data, and set or clear their marks in a single operation.

1. In the screen where you're selecting sound data, select the lowest-numbered item of sound data that you want to select.
2. Hold down the [SHIFT] button and use the cursor [▲][▼] buttons to select the highest-numbered item of sound data that you want to select.



All sounds between the numbers you selected in steps 1 and 2 will be selected.

The number of currently selected data items is shown in the upper right of the screen.

3. Press the [INC] button.

Pressing the [DEC] button will clear the mark from the sound data.

Deleting an Exported File

In the screen where you select the data file to be imported, you can delete data files.

1. In the UTILITY screen, choose "IMPORT" and press the [ENTER] button.
The IMPORT screen will appear.
2. Select the data file that you want to delete.

NOTE

Data that you delete cannot be recovered.
Take care not to inadvertently delete important data.

3. Press the [MENU] button.
4. Choose "DELETE" and press the [ENTER] button.
A message will ask "Are you sure?"
5. Choose "OK" and press the [ENTER] button.

Renaming an Exported File

In the screen where you select the data file to be imported, you can rename the data file.

1. In the UTILITY screen, choose "IMPORT" and press the [ENTER] button.
The IMPORT screen will appear.
2. Select the data file that you want to rename.
3. Press the [MENU] button.
4. Choose "RENAME" and press the [ENTER] button.
For details on assigning a name, refer to "Assigning a Name" (p. 29).
5. Press the [ENTER] button.

Backing Up User Data

You can back up all of settings in the INTEGRA-7 to a USB flash drive (sold separately), or restore those settings into the INTEGRA-7's memory.

* Connect your USB flash drive to the USB MEMORY port before you back up or restore data.

NOTE

- If you execute the backup operation using a file name that already exists, the backup data currently saved on the USB flash drive will be overwritten. If you want to keep multiple backup files within a single USB flash drive, you can either back them up with different file names, or back them up as described in "Backing Up USB Flash Drive Data to a Computer" (p. 53).
- Never insert or remove a USB flash drive while this unit is on. Doing so may corrupt the unit's data or the data on the USB flash drive.
- Carefully insert the USB flash drive all the way in-until it is firmly in place.
- Use USB flash drive available from Roland. Proper operation cannot be guaranteed if other USB device is used.

Backing Up to a USB Flash Drive (BACKUP)

1. In the UTILITY screen, choose "BACKUP" and press the [ENTER] button.
2. Assign a name to the backup file.
For details on assigning a name, refer to "Assigning a Name" (p. 29).
3. Press the [ENTER] button.
A message will ask "Are you sure?"
4. To execute, choose "OK" and press the [ENTER] button.

NOTE

Never turn off the unit while the backup operation is in progress.

Restoring Backed-up Settings from a USB Flash Drive (RESTORE)

1. In the UTILITY screen, choose "RESTORE" and press the [ENTER] button.

The RESTORE screen will appear.

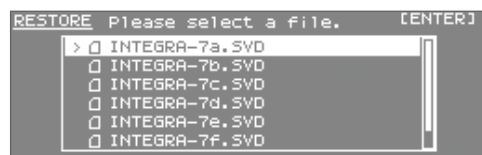

2. Select the file that you want to restore.
3. Press the [ENTER] button.

A message will ask "Are you sure?"

NOTE

When you execute the Restore operation, all settings currently saved in the INTEGRA-7 will be lost. If you want to keep the current settings, back them up under a different name.

4. To execute, choose "OK" and press the [ENTER] button.

NOTE

Never turn off the unit while the restore operation is in progress.

5. Turn the INTEGRA-7 off, and then on again.

Deleting a Backup File

You can delete a data file in the screen where you select a data file to be restored.

1. In the UTILITY screen, choose "RESTORE" and press the [ENTER] button.

The RESTORE screen will appear.

2. Select the data file that you want to delete.

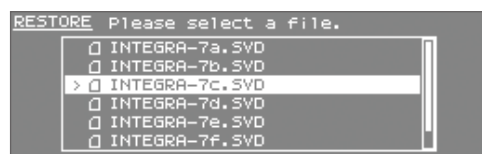

NOTE

Data that you delete cannot be recovered.

Take care not to inadvertently delete important data.

3. Press the [MENU] button.
4. Choose "DELETE" and press the [ENTER] button.
A message will ask "Are you sure?"
5. Choose "OK" and press the [ENTER] button.

Renaming a Backup File

You can rename a data file in the screen where you select a data file to be restored.

1. In the UTILITY screen, choose "RESTORE" and press the [ENTER] button.

The RESTORE screen will appear.

2. Select the data file that you want to rename.

3. Press the [MENU] button.

4. Choose "RENAME" and press the [ENTER] button.

For details on assigning a name, refer to "Assigning a Name" (p. 29).

5. Press the [ENTER] button.

Backing Up USB Flash Drive Data to a Computer

Here's how to back up the data from a USB flash drive to your computer.

1. Turn off the INTEGRA-7.
2. Disconnect the USB flash drive from the INTEGRA-7, and connect it to your computer.
3. On your computer, open the USB flash drive.
4. Copy (drag and drop) the entire "ROLAND" folder from the USB flash drive into a folder on your computer.

NOTE

- You must copy the entire "ROLAND" folder.
- The data will not be backed up correctly if you copy only part of the files in the "ROLAND" folder.

5. When the copy is completed, unmount (eject) the USB flash drive from your computer, and then disconnect it from the computer.

Windows 7 / Windows Vista / Windows XP users:

In My Computer (or Computer), right-click the "removable disk" icon and choose "Eject."

Mac OS X users:

Drag the USB flash drive icon into the Trash (Eject icon).

Restoring Backed-up Data from a Computer to a USB Flash Drive

1. Connect the USB flash drive to your computer, and open the USB flash drive.
2. Copy (drag and drop) the entire backed-up "ROLAND" folder from your computer into the USB flash drive.

NOTE

- When you copy the backed-up data to the USB flash drive, the "ROLAND" folder that previously existed on the USB flash drive will be overwritten, and its data will be lost.
 - You must copy the entire "ROLAND" folder. The system will not operate correctly if you copy only some of the files from the "ROLAND" folder.
3. Disconnect the USB flash drive from your computer as described in step 5 of "Backing Up USB Flash Drive Data to a Computer" (p. 53).

Transmitting the Temporary Area's Data to an External MIDI Device (BULK DUMP)

Here's how to transmit the studio set and tone settings to an external MIDI device. This operation is called "bulk dump." You can use this operation when you want to connect another INTEGRA-7 unit and play it using identical settings, or when you want to save your studio set and tone settings on an external MIDI device as a precaution against data loss.

Connect the INTEGRA-7 to your external MIDI device as shown in the illustration before you proceed.

INTEGRA-7

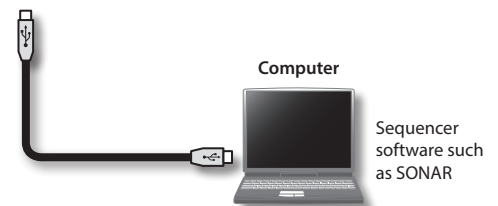

1. In the UTILITY screen, choose "BULK DUMP" and press the [ENTER] button.
A message will ask "Are you sure?"
2. To execute the bulk dump, choose "OK" and press the [ENTER] button.

Restoring the Factory Settings (FACTORY RESET)

This "FACTORY RESET" operation will restore all settings of the INTEGRA-7 to their factory-set state.

NOTE

When you execute the Factory Reset operation, all data in the INTEGRA-7 will be lost. If there is any data that you want to keep, back it up to a USB flash drive (p. 52).

1. In the MENU screen, choose "UTILITY" and press the [ENTER] button.
The UTILITY screen will appear.
2. Choose "FACTORY RESET" and press the [ENTER] button.



3. To execute the factory reset, choose "OK" and press the [ENTER] button.

NOTE

Never turn off the unit before the factory reset has been completed.

4. Turn the INTEGRA-7 off, and then on again.

Making the Unit Automatically Turn Off After a Time (Auto Off)

With the factory settings, the INTEGRA-7 will automatically be switched off 4 hours after you stop playing or operating the unit.

If you don't need the unit to turn off automatically, set "Auto Off" to the "OFF" setting as described below.

1. In the MENU screen, choose "SYSTEM" and press the [ENTER] button.
The SYSTEM screen will appear.
2. Use the cursor [◀] [▶] buttons to select the "SETUP" tab.
3. Use the cursor [▲] [▼] buttons to select "Auto Off," and change the setting.

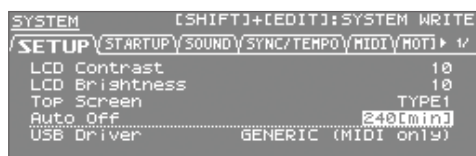

Value	Value
OFF	The unit will not turn off automatically.
30 [min]	The unit will automatically turn off if no operation is performed for 30 minutes.
240 [min] (default)	The unit will automatically turn off if no operation is performed for 240 minutes (4 hours).

4. Hold down the [SHIFT] button and press the [EDIT] button.

A message will indicate "Completed!" and the settings will be saved.

NOTE

- Never turn off the unit while data is being saved.
- When turning the unit back on after it has been shut down due to the Auto Off function, always make sure to allow at least ten seconds to pass after the unit has been shut off before you turn the unit back on. If you turn it back on too rapidly, the Auto Off function will not have had enough time to reset itself, and you may not be able to turn on the unit in the normal way.

Troubleshooting

Problem	Items to check	Action	Page
Overall problems			
The unit turns off unexpectedly	Check the "Auto Off" system setting. The INTEGRA-7 will automatically be turned off when no operation has been performed for a certain length of time. (At the factory settings, the power will be turned off after 4 hours.)	If you want the INTEGRA-7 to stay on, change the "Auto Off" system setting to "OFF."	p. 55
Unit won't turn on	Is the included AC power cord correctly connected to an outlet and to the INTEGRA-7?	Make sure that the AC power cord is connected correctly. Do not use anything other than the included AC power cord; otherwise, you risk causing a malfunction.	p. 22
No sound	Is the connected amp or speaker powered up?	Turn on the power of the connected amp or speaker.	p. 21
	Could the volume of a connected device have been lowered?	Adjust the volume of the connected equipment.	
	Could the [VOLUME] knob be set to the minimum level?	Adjust the [VOLUME] knob.	
	Are your amp, speakers, headphones, etc., connected correctly?	Correctly connect your amp, speakers, and headphones.	p. 23
	Can you connect headphones and hear sound through them?	If you hear sound through your headphones, it may be that there is a broken connection cable, or that your amp or mixer have malfunctioned. Check your connection cables and equipment once again.	p. 20
	Does the MIDI receive channel match?	Make sure that the MIDI transmit channel of the connected device matches the MIDI receive channel (Rx Channel) of the INTEGRA-7.	p. 32
	Could you be using a connection cable that contains a resistor?	Use a connection cable that does not contain a resistor.	p. 23
Problems with the Synthesizer sound			
No sound	Could the tone's partials be turned off?	Turn on the "Partial Switch."	p. 42
	Could the level setting be too low?	In the "SOUND" system settings, check "Master Level."	p. 48
	Are the effect settings correct?	Check the effect on/off settings. Also check settings such as the effect levels.	p. 36, p. 41
	Has the expansion sound data been loaded correctly?	If the settings of the sound use a tone, wave, or instrument of an expansion sound, make sure that the corresponding expansion sound data is loaded correctly.	p. 15
	Could the volume have been lowered by a MIDI message (volume message or expression message) received from an external MIDI device?	Adjust the Level setting to raise the volume of the part that you don't hear. Check the expression messages that are being transmitted by your external MIDI device.	p. 32
	Could the USB-MIDI Thru setting be ON?	If USB-MIDI Thru is on, MIDI messages received at MIDI IN will be re-transmitted without change from USB OUT, so the sound generator will not produce sound. If you want to play the sound generator via the MIDI IN connector, turn USB-MIDI Thru off.	p. 45
No sound from a specific part	Could the volume level of the part have been lowered?	Adjust the Level to raise the volume of the part that you don't hear.	p. 32
	Could the part be muted?	Change the mute setting to "-".	p. 30
	Could the Rx Switch of the part be turned off?	Turn the Rx Switch on.	p. 32
No sound from a specific range of keys	Could a key range be set?	If you don't hear sound from a specific range of keys, check the key range settings.	p. 32
Can't hear the audio signal from the computer	Could the audio signal from the computer be at a different sampling rate than the sampling rate of the INTEGRA-7 itself?	Change the Sampling Rate setting of the INTEGRA-7 so that it matches the sampling rate of the audio signal.	p. 48
Sound is distorted	Could the [VOLUME] knob be set too high?	If the overall sound is distorted, lower the [VOLUME] knob.	p. 21
	Could the Output Gain be raised excessively?	In the "SOUND" system settings, check the "Output Gain" setting.	p. 48
	Could the INPUT (front or rear) input signal be too high?	The PEAK indicator on the front panel will light if the input level clips. Adjust the volume of the connected device to an appropriate level so that the PEAK indicator does not light.	-
Pitch is wrong	Could the INTEGRA-7's tuning be incorrect?	In the "SOUND" system settings, check the "Master Tune" setting.	p. 48
	Could the pitch be wrong because of a pitch bend message received from an external MIDI device?	Check the pitch bend messages that are being transmitted by your external MIDI device.	-
	Could the Coarse Tune or Fine Tune parameters be set?	Check the Coarse Tune and Fine Tune settings.	p. 33
Notes are broken off	Notes will be interrupted if more than 128 notes are sounded simultaneously.	Reduce the number of layers in the Live Set you're using. Increase the voice reserve setting for layers in which notes must not drop out.	p. 32
Sound is still heard from the opposite side as well even when panned all the way to one side	Could effects be applied?	Since the INTEGRA-7's internal effects are stereo, applying an insert effect will allow effect sound to be heard from the opposite side even if the source sound is panned all the way to one side.	p. 36, p. 41
	Could Motional Surround be turned on?	PAN will not work if Motional Surround is on. Turn MOTIONAL SURROUND off.	p. 34
Notes played in a high register sound funny	When you play high notes on the INTEGRA-7, you might hear notes that fail to sound, whose pitch fails to rise, or a noise that changes depending on the note you play (a warbling, chirping, rustling, beeping, etc.)	This is usually because you have exceeded the highest note that the INTEGRA-7 is able to produce, and won't occur with the notes you would normally use. This does not indicate a malfunction.	-

Problem	Items to check	Action	Page
Delay time does not change when you change the tempo	Could the system setting "USB Song Sync Mode" have been set to "SLAVE"?	If "Sync Mode" is set to "SLAVE," change the tempo of the external device that is transmitting MIDI clock data.	p. 48
Pitch sometimes fails to rise when playing legato	When the Legato Switch (p. 32) is "ON" and Legato Retrigger is "OFF," and you hold down a low note and play a high note to produce a legato effect, the pitch might stop at a certain point and fail to rise as far as you expect because the upper limit of the wave data has been exceeded. If the tone uses multiple waves, and each of these waves has a different upper limit, the result might no longer sound mono.	If you want to make large changes in the pitch, you should turn Legato Retrigger "ON." For details on the parameters, refer to "Parameter Guide PDF."	p. 39
Problems with the Synthesizer effects			
Effect not applied	Could the effect switch be off?	Check the on/off setting of each effect.	p. 36, p. 41
	Check the send level to each effect.	The effect won't be obtained if the send level to that effect is set at 0. Even if the send levels to the effect is set above 0, the effect won't be applied if the multi-effect level, or reverb level are set to 0. Check each of these settings.	p. 36
You specified a delay time value (for example for multi effect DELAY) as a note value, but there's a limit beyond which the delay time will not change	Check the delay time setting.	Increase the System tempo. Since the delay time has an upper limit, specifying the delay time as a note value and then slowing down the tempo may reach this upper limit. The maximum delay time is the highest value that can be specified numerically (i.e., other than in terms of a note value).	p. 48
Problems with external MIDI devices			
No sound from an external MIDI device	Does the INTEGRA-7's MIDI transmit channel match the connected device's MIDI receive channel?	Match the INTEGRA-7's transmit channel and your connected device's receive channel.	p. 32
Exclusive messages are not received	Could Rx Exclusive be turned "OFF"?	Turn Rx Exclusive "ON."	p. 49
	Does the transmitting unit's Device ID number match the INTEGRA-7's Device ID number?	Set the Device ID numbers.	p. 49
Problems with an external device you're recording			
The volume level of the instrument connected to INPUT jacks (Front, Rear) is too low.	Could you be using a connection cable that contains a resistor?	Use a connection cable that does not contain a resistor.	p. 23
	Is the volume of the external device adjusted correctly?	Adjust the volume of your external device to an appropriate level.	–
	Did you adjust the Level of Ext Part?	Adjust Level of Ext Part.	p. 33
Problems with the USB flash drive			
USB flash drive is not recognized	Check the format of the USB flash drive.	Format the USB flash drive on the INTEGRA-7. The INTEGRA-7 can use a USB flash drive that's formatted as FAT. (Normally, a USB flash drive will be formatted as FAT when you purchase it, so you can use it as is.) USB flash drives with a format other than FAT (such as NTFS) will not be recognized by the INTEGRA-7.	p. 50
Data on the USB flash drive was damaged	Could a strong physical shock have been applied to the USB flash drive?	Format the USB flash drive on the INTEGRA-7.	p. 50
	Could the unit have been turned off while accessing the USB flash drive?		
Can't back up to USB flash drive	Is there sufficient free space on the USB flash drive?	Use an USB flash drive that has sufficient free space.	–
	Check the format of the USB flash drive. The INTEGRA-7 can use USB flash drive that are formatted in FAT format.	Format the USB flash drive on the INTEGRA-7.	p. 50
Problems with a USB connection			
The INTEGRA-7 is not recognized by your computer	Does your computer's USB port support USB 2.0 Hi-Speed?	The USB port of the computer connected to the INTEGRA-7 must support USB 2.0 Hi-Speed.	–

Error Message List

If an incorrect operation is performed, or if processing could not be performed as you specified, an error message will appear. Refer to the explanation for the error message that appears, and take the appropriate action.

Message	Meaning	Action
Cannot Import!	Sound data cannot be imported.	An import destination has not been selected. Select the import destination (p. 51).
File Not Selected!	No file is selected.	Select a file.
Incorrect File Name!	The file name is invalid.	Do not use a file name that starts with "" or contains a character that may not be used (¥ / ; * ? " < >) in a file name.
MIDI Buffer Full!	An unusually large amount of MIDI data was received, and could not be processed.	Reduce the amount of MIDI messages that are being transmitted.
MIDI Offline!	The MIDI IN connection was broken.	Check that there is no problem with the MIDI cable connected to the INTEGRA-7's MIDI IN, and that the MIDI cable was not disconnected.
Permission Denied!	The operation could not be performed because the read-only attribute is set for the folder or file.	Use your computer to clear the read-only attribute of the file or folder.
Program Error!	The INTEGRA-7 was unable to start up. The program could not be read correctly. Alternatively, the system update program may be invalid.	Use the correct program to perform the update once again. If this does not solve the problem, contact your dealer or customer support.
Read Error!	Data could not be read from the USB flash drive.	Make sure that USB flash drive is correctly connected (p. 5). Also make sure that you're using a USB flash drive sold by Roland.
	The file is damaged.	Do not use this file.
System Memory Damaged!	The contents of system memory may be damaged.	Execute the factory reset operation (p. 55). If this does not solve the problem, contact your dealer or customer support.
USB Memory Full!	There is insufficient space on the USB flash drive.	Delete unneeded data (p. 52, p. 53).
USB Memory Not Ready!	The USB flash drive is not inserted, or is inserted incompletely.	Turn off the unit, firmly insert the USB flash drive, and then turn on the unit once again (p. 5, p. 21).
	The USB flash drive was removed after you selected data that was on the USB flash drive.	
	The format of the USB flash drive is invalid.	Use the INTEGRA-7 to format the USB flash drive (p. 50).
Write Error!	Data could not be written to the USB flash drive.	Make sure that USB flash drive is correctly connected (p. 5). Also make sure that you're using a USB flash drive sold by Roland.
	The format of the USB flash drive is invalid.	Use the INTEGRA-7 to format the USB flash drive (p. 50).

MIDI Implementation Chart

Date : Jun. 1, 2012

Model INTEGRA-7

Version : 1.00

Function...	Transmitted	Recognized	Remarks	
Basic Default	x	1-16		
Channel Changed	x	1-16		
Mode Default	x	Mode 3	*2	
Message Altered	x *****	Mode 3, 4 (M=1)		
Note Number : True Voice	x *****	0-127 0-127		
Velocity Note On	x	o		
Note Off	x	o		
After Key's	x	o *1		
Touch Channel's	x	o *1		
Pitch Bend	x	o *1		
Control Change	0, 32	x	o *1	Bank select
	1	x	o *1	Modulation
	2	x	o	Breath type
	4	x	o	Foot type
	5	x	o	Portamento time
	6, 38	x	o	Data entry
	7	x	o *1	Volume
	10	x	o	Panpot
	11	x	o *1	Expression
	12	x	o (Part L-R)	*4 Effect control 1
	13	x	o (Part F-B)	*4 Effect control 2
	14	x	o (Part Ambience Send)	*4
	16	x	o (Tone Modify 1)	General purpose controller 1
	17	x	o (Tone Modify 2)	General purpose controller 2
	18	x	o (Tone Modify 3)	General purpose controller 3
	19	x	o (Tone Modify 4)	General purpose controller 4
	28	x	o (Ext Part L-R)	*4
	29	x	o (Ext Part F-B)	*4
	30	x	o (Ext Part Ambience Send)	*4
	64	x	o	*1 Hold 1
	65	x	o	Portamento
	66	x	o	Sostenuto
	67	x	o	Soft
	68	x	o	Legato foot switch
	71	x	o	Resonance
	72	x	o	Release time
	73	x	o	Attack time
	74	x	o	Cutoff
	75	x	o	Decay time
	76	x	o	Vibrato rate
	77	x	o	Vibrato depth
	78	x	o	Vibrato delay
80	x	o (Tone Variation 1)	General purpose controller 5	
81	x	o (Tone Variation 2)	General purpose controller 6	
82	x	o (Tone Variation 3)	General purpose controller 7	
83	x	o (Tone Variation 4)	General purpose controller 8	
84	x	o	Portamento control	
91	x	o (Reverb)	General purpose effect 1	
93	x	o (Chorus)	General purpose effect 3	
1-31, 33-95	x	o	General purpose controller	
96, 97	x	x	Increment, Decrement	
98, 99	x	x	NRPN LSB, MSB	
100, 101	x	o	RPN LSB, MSB	
102, 119	x	x		
Program Change : True Number	x *****	o *1 0-127	Program Number 1-128	
System Exclusive	o *3	o *1		
System : Song Position	x	x		
Common : Song Select	x	x		
: Tune	x	x		
System : Clock	x	o		
Realtime : Commands	x	x		
Aux : All Sound Off	x	o		
Messages : Reset All Controllers	x	o		
: Local On/Off	x	x		
: All Notes Off	x	o (123-127)		
: Active Sensing	x	o		
: System Reset	x	x		
Notes	*1 O X is selectable. *2 Recognized as M=1 even if M≠1. *3 Transmitted only when "Transmitted Edit Data" is ON or RQ1 is received. *4 Motional Surround setting; valid when Motional Surround is on.			

Mode 1: Omni On, Poly
Mode 3: Omni Off, Poly

Mode 2: Omni On, Mono
Mode 4: Omni Off, Mono

o: Yes
x: No

Quick Guide

Introduction

Playing/Creating Sounds

Use with a Computer

Overall Settings

Appendix

Specifications

Roland INTEGRA-7: SuperNATURAL Sound Module

Sound Generator Section	
Maximum Polyphony	128 voices (varies according to the sound generator load)
Parts	16 parts
Tones	SuperNATURAL Acoustic SuperNATURAL Synth SuperNATURAL Drum Kit PCM Synth PCM Drum Kit * GM2 compatible sounds are included.
Expansion Virtual Slots	4 Slots * The following titles are loaded from the internal memory into the virtual slots. SRX Series (12 titles) <ul style="list-style-type: none"> • SRX-01 Dynamic Drum Kits • SRX-02 Concert Piano • SRX-03 Studio SRX • SRX-04 Symphonique Strings • SRX-05 Supreme Dance • SRX-06 Complete Orchestra • SRX-07 Ultimate Keys • SRX-08 Platinum Trax • SRX-09 World Collection • SRX-10 Big Brass Ensemble • SRX-11 Complete Piano • SRX-12 Classic EPs Expansion SuperNATURAL Sounds (6 titles) <ul style="list-style-type: none"> • ExSN1 Ethnic • ExSN2 Wood Winds • ExSN3 Session • ExSN4 A. Guitar • ExSN5 Brass • ExSN6 SFX Expansion Hi-Quality PCM Sounds (1 title) <ul style="list-style-type: none"> • ExPCM HQ GM2 + HQ PCM Sound Collection * The SRX Series and the Expansion SuperNATURAL Sounds use one virtual slot per title. * The Expansion Hi-Quality PCM Sounds use all four virtual slots.
Effects	<ul style="list-style-type: none"> • Multi-Effects: 16 systems, 67 types • Part EQ: 16 systems • Drum Part COMP+EQ: 6 systems • Motional Surround • Chorus: 3 types • Reverb: 6 types • Master EQ

Others	
Display	256 x 80 dots graphic LCD (with backlit)
Connectors	<ul style="list-style-type: none"> • PHONES jack (stereo 1/4-inch phone type) • INPUT jacks (L, R) (1/4-inch phone type, Front) • INPUT jacks (L, R) (1/4-inch phone type, Rear) • OUTPUT A (MIX) jacks (L, R) (1/4-inch TRS phone type) • OUTPUT A (MIX) jacks (L, R) (XLR type) • OUTPUT B jacks (L, R) (1/4-inch phone type) • OUTPUT C jacks (L, R) (1/4-inch phone type) • OUTPUT D jacks (L, R) (1/4-inch phone type) • DIGITAL AUDIO OUT jack (COAXIAL) • MIDI Connectors (IN, OUT, THRU) • USB COMPUTER port (Audio/MIDI) • USB Memory port • AC IN jack
Power Consumption	18 W
Dimensions	481 (W) x 262 (D) x 89 (H) mm 18-15/16 (W) x 10-3/8 (D) x 3-9/16 (H) inches
Weight	3.9 kg 8 lbs 10 oz
Accessories	<ul style="list-style-type: none"> • Owner's Manual • DVD-ROM (SONAR LE) • Power Cord
Options (sold separately)	USB Flash Memory * Use USB Flash Memory sold by Roland. We cannot guarantee operation if other products are used.

* In the interest of product improvement, the specifications and/or appearance of this unit are subject to change without prior notice.

Index

Symbols

2CH Out Mode	49
5.1 channel surround	16, 47
5.1CH Center SP Switch	49
5.1CH Sub Woofer (LFE) Switch	49
[⏻] switch	21

A

AC IN jack	22
Assigning a Name	29
Auto Off	48, 55

B

BACKUP	
Computer	53
USB Flash Drive	52
Backup File	
Delete	53
Rename	53
Bank	25
Behavior Modeling Technology	8
BULK DUMP	54

C

Cannot Import!	58
CHORUS	26, 36
Clock Source	48
COMP	41
Compressor	41
Compressor + Equalizer	26
Computer	43
Backup	53
Connection example	
Compact production setup	10
For live performance	11
Motional Surround	16
Motional Surround (external device)	47
Control Source Select	49
Copy	
Partial	42
Cursor buttons	28

D

[DEC] button	28
Delete	
Backup File	53
Character	29
Exported File	52
Demo Song	21
Device ID	49
DIGITAL AUDIO OUT connector	22
Display	20
Drum Kit	
Save	40

E

Edit	
Effect	36, 41
Partial	42
PCM Drum Kit (PCMD)	40
PCM Synth Tone (PCMS)	39
Studio Set	32
SuperNATURAL Acoustic Tone (SN-A)	38
SuperNATURAL Drum Kit (SN-D)	39
SuperNATURAL Synth Tone (SN-S)	38
Tone	38
Effect	26, 41
Edit	36
[ENTER] button	20, 29
EQ	41
Equalizer	26, 41
Error Message List	58

[EXIT] button	20
Expansion Sound Data	14
EXPANSION Virtual Slot	14, 27
ExpPCM sounds	15
EXPORT	
Sound Data	51
Exported File	
Delete	52
Rename	52
Ext Part Source Select	48

F

FACTORY RESET	55
File Not Selected!	58
FORMAT USB MEMORY	50

I

IMPORT	
Sound Data	51
[INC] button	28
Incorrect File Name!	58
Initialize	
Part	37
Partial	42
Sound Control	37
Studio Set	37
Tone	42
USB Flash Drive	50
INPUT L/R jacks	
Front	20
Rear	22
Insert	
Character	29
Inst.	25

L

LCD	
Brightness	48
Contrast	48

M

MASTER EQ	26, 36
Master Key Shift	48
Master Level	48
Master Tune	48
[MENU] button	20
MFX	41
MIDI Buffer Full!	58
MIDI connectors	22
MIDI indicator	20
MIDI Offline!	58
Motional Surround	9, 17, 26, 34, 47
[MOTIONAL SURROUND] button	34
Multi-Effect	26, 41
MUTE	30

O

Output Gain	48
OUTPUT jacks	
A (MIX) L/MONO, R jacks	23
B, C, D L/R jacks	23
INDIVIDUAL 1-8 jacks	23
RSS L/R jacks	23
SURROUND L/R/C/Ls/Rs/LFE jacks	23

P

Part	25
Initialize	37
PART [◀] [▶] buttons	28
Partial	25
Copy	42
Edit	42
Initialize	42

[PART VIEW] button	30
[PCM] button	31
PCM Drum Kit	9, 13, 24
PCM Synth Tone	9, 13, 24
PCM Tone	9, 24
PEAK indicator	20
Permission Denied!	58
PHONES jacks	20
Preset Memory	27
Preview 1-4 Note	49
Preview 1-4 Velo	49
Preview Mode	49
Program Error!	58

R

Rack-mount bracket	20
Read Error!	58
Rename	
Backup File	53
Exported File	52
RESTORE	
USB Flash Drive	53
REVERB	26, 36
Rx Bank Select	49
Rx Exclusive	49
Rx GM2 System On	49
Rx GM System On	49
Rx GS Reset	49
Rx Program Change	49

S

Sampling Rate	46, 48
Save	
Drum Kit	40
Studio Set	34
System	48
Tone	40
Setting	
System	48
[SHIFT] Button	29
Shortcut list	29
SOLO	30
SONAR LE	18
Sound Control	
Initialize	37
Sound Data	
Export	51
Import	51
SRX series sounds	15
Startup Exp SlotA-SlotD	48
Startup Studio Set	48
Studio Set	25
Edit	32
Initialize	37
Save	34
Studio Set Control Channel	49
SuperNATURAL	8
SuperNATURAL Acoustic	
Tone	8, 13, 24
[SuperNATURAL] button	31
SuperNATURAL Drum Kit	8, 13, 24
SuperNATURAL Synth Tone	8, 13, 24
SuperNATURAL Tone	8, 24
Switching Parts	28
Sync Mode	48
System	
Setting	48
System Control Src1-4	49
System Memory	27
System Memory Damaged!	58
System Setting	
Save	48
System Tempo	48
System Version	49

T

Tempo Assign Source	48
Temporary Area	27
Tone	24
Edit	38
Initialize	42
Save	40
[TONE FINDER] button	31
Tone List	
Bank	31
Category	31
Drum Kit	31
Type	31
Top Screen	48
Tx Edit Data	49

U

USB Audio	43, 46
USB COMPUTER port	22
USB Driver	43, 44, 48
USB Flash Drive	50
Backup	52
Initialize	50
Restore	53
USB Flash Drive Data	
Backup	53
USB indicator	20
USB Memory	27
USB Memory Full!	58
USB Memory Not Ready!	58
USB MEMORY port	20
USB MIDI	43, 45
USB-MIDI Thru	49
User Memory	27
Utility	50

V

Value dial	28
[VOLUME] knob	20

W

Write Error!	58
--------------------	----

MEMO

Quick Guide

Introduction

Playing/Creating Sounds

Use with a Computer

Overall Settings

Appendix

MEMO

MEMO

Quick Guide

Introduction

Playing/Creating Sounds

Use with a Computer

Overall Settings

Appendix

For EU Countries



- UK** This symbol indicates that in EU countries, this product must be collected separately from household waste, as defined in each region. Products bearing this symbol must not be discarded together with household waste.
- DE** Dieses Symbol bedeutet, dass dieses Produkt in EU-Ländern getrennt vom Hausmüll gesammelt werden muss gemäß den regionalen Bestimmungen. Mit diesem Symbol gekennzeichnete Produkte dürfen nicht zusammen mit dem Hausmüll entsorgt werden.
- FR** Ce symbole indique que dans les pays de l'Union européenne, ce produit doit être collecté séparément des ordures ménagères selon les directives en vigueur dans chacun de ces pays. Les produits portant ce symbole ne doivent pas être mis au rebut avec les ordures ménagères.
- IT** Questo simbolo indica che nei paesi della Comunità europea questo prodotto deve essere smaltito separatamente dai normali rifiuti domestici, secondo la legislazione in vigore in ciascun paese. I prodotti che riportano questo simbolo non devono essere smaltiti insieme ai rifiuti domestici. Ai sensi dell'art. 13 del D.Lgs. 25 luglio 2005 n. 151.
- ES** Este símbolo indica que en los países de la Unión Europea este producto debe recogerse aparte de los residuos domésticos, tal como esté regulado en cada zona. Los productos con este símbolo no se deben depositar con los residuos domésticos.
- PT** Este símbolo indica que nos países da UE, a recolha deste produto deverá ser feita separadamente do lixo doméstico, de acordo com os regulamentos de cada região. Os produtos que apresentem este símbolo não deverão ser eliminados juntamente com o lixo doméstico.
- NL** Dit symbool geeft aan dat in landen van de EU dit product gescheiden van huishoudelijk afval moet worden aangeboden, zoals bepaald per gemeente of regio. Producten die van dit symbool zijn voorzien, mogen niet samen met huishoudelijk afval worden verwijderd.
- DK** Dette symbol angiver, at i EU-lande skal dette produkt opsamles adskilt fra husholdningsaffald, som defineret i hver enkelt region. Produkter med dette symbol må ikke smides ud sammen med husholdningsaffald.
- NO** Dette symbolet indikerer at produktet må behandles som spesialavfall i EU-land, iht. til retningslinjer for den enkelte regionen, og ikke kastes sammen med vanlig husholdningsavfall. Produkter som er merket med dette symbolet, må ikke kastes sammen med vanlig husholdningsavfall.

- SE** Symbolen anger att i EU-länder måste den här produkten kasseras separat från hushållsavfall, i enlighet med varje regions bestämmelser. Produkter med den här symbolen får inte kasseras tillsammans med hushållsavfall.
- FI** Tämä merkintä ilmaisee, että tuote on EU-maissa kerättävä erillään kotitalousjätteistä kunkin alueen voimassa olevien määräysten mukaisesti. Tällä merkinnällä varustettuja tuotteita ei saa hävittää kotitalousjätteiden mukana.
- HU** Ez a szimbólum azt jelenti, hogy az Európai Unióban ezt a terméket a háztartási hulladéktól elkülönítve, az adott régióban érvényes szabályozás szerint kell gyűjteni. Az ezzel a szimbóllummal ellátott termékeket nem szabad a háztartási hulladék közé dobni.
- PL** Symbol oznacza, że zgodnie z regulacjami w odpowiednim regionie, w krajach UE produktu nie należy wyrzucać z odpadami domowymi. Produktów opatrzonych tym symbolem nie można utylizować razem z odpadami domowymi.
- CZ** Tento symbol udává, že v zemích EU musí být tento výrobek sbírán odděleně od domácího odpadu, jak je určeno pro každý region. Výrobky nesoucí tento symbol se nesmí vyhazovat spolu s domácím odpadem.
- SK** Tento symbol vyjadruje, že v krajinách EÚ sa musí zber tohto produktu vykonávať oddelene od domového odpadu, podľa nariadení platných v konkrétnej krajine. Produkty s týmto symbolom sa nesmú vyhazovať spolu s domovým odpadom.
- EE** See sümbol näitab, et EL-i maades tuleb see toode olemprügist eraldi koguda, nii nagu on igas piirkonnas määratletud. Selle sümboliga märgitud tooteid ei tohi ära visata koos olmeprügiga.
- LT** Šis simbolis rodo, kad ES šalyse šis produktas turi būti surenkamas atskirai nuo buitinių atliekų, kaip nustatyta kiekviename regione. Šiuo simboliu paženklinėti produktai neturi būti išmetami kartu su buitinėmis atliekomis.
- LV** Šis simbols norāda, ka ES valstīs šo produktu jāievāc atsevišķi no mājsaimniecības atkritumiem, kā noteikts katrā reģionā. Produkts ar šo simbolu nedrīkst izmest kopā ar mājsaimniecības atkritumiem.
- SI** Ta simbol označuje, da je treba proizvod v državah EU zbirati ločeno od gospodinskih odpadkov, tako kot je določeno v vsaki regiji. Proizvoda s tem znakom ni dovoljeno odlagati skupaj z gospodinskimi odpadki.
- GR** Το σύμβολο αυτό υποδηλώνει ότι στις χώρες της Ε.Ε. το συγκεκριμένο προϊόν πρέπει να συλλέγεται χωριστά από τα υπόλοιπα οικιακά απορρίμματα, σύμφωνα με όσα προβλέπονται σε κάθε περιοχή. Τα προϊόντα που φέρουν το συγκεκριμένο σύμβολο δεν πρέπει να απορρίπτονται μαζί με τα οικιακά απορρίμματα.

For China

有关产品中所含有害物质的说明

本资料就本公司产品中所含的特定有害物质及其安全性予以说明。
本资料适用于2007年3月1日以后本公司所制造的产品。

环保使用期限



此标志适用于在中国国内销售的电子信息产品，表示环保使用期限的年数。所谓环保使用期限是指在自制造日起的规定期限内，产品中所含的有害物质不致引起环境污染，不会对人身、财产造成严重的不良影响。
环保使用期限仅在遵照产品使用说明书，正确使用产品的条件下才有效。
不当的使用，将会导致有害物质泄漏的危险。

产品中有害物质的名称及含量

部件名称	有害物质					
	铅 (Pb)	汞 (Hg)	镉 (Cd)	六价铬 (Cr(VI))	多溴联苯 (PBB)	多溴二苯醚 (PBDE)
外壳(壳体)	×	○	○	○	○	○
电子部件(印刷电路板等)	×	○	×	○	○	○
附件(电源线、交流适配器等)	×	○	○	○	○	○

本表格依据SJ/T 11364的规定编制。

○：表示该有害物质在该部件所有均质材料中的含量均在GB/T 26572 规定的限量要求以下。

×：表示该有害物质至少在该部件的某一均质材料中的含量超出GB/T 26572的限量要求。

(企业可在此处，根据实际情况对上表中打“×”的技术原因进行进一步说明。)

For the USA

DECLARATION OF CONFORMITY Compliance Information Statement

Model Name : INTEGRA-7
 Type of Equipment : Sound Module
 Responsible Party : Roland Corporation U.S.
 Address : 5100 S. Eastern Avenue Los Angeles, CA 90040-2938
 Telephone : (323) 890-3700

For the USA

FEDERAL COMMUNICATIONS COMMISSION RADIO FREQUENCY INTERFERENCE STATEMENT

This equipment has been tested and found to comply with the limits for a Class A digital device, pursuant to Part 15 of the FCC Rules. These limits are designed to provide reasonable protection against harmful interference when the equipment is operated in a commercial environment. This equipment generates, uses, and can radiate radio frequency energy and, if not installed and used in accordance with the instruction manual, may cause harmful interference to radio communications. Operation of this equipment in a residential area is likely to cause harmful interference in which case the user will be required to correct the interference at his own expense.

This device complies with Part 15 of the FCC Rules. Operation is subject to the following two conditions:

- (1) this device may not cause harmful interference, and
- (2) this device must accept any interference received, including interference that may cause undesired operation.

To assure continued FCC emission limit compliance, use only shielded interface cables when connecting to other device. Any unauthorized changes or modifications not expressly approved by the party responsible for compliance could void the user's authority to operate the equipment.

For Canada

CAN ICES-3 (A)/NMB-3 (A)

For Korea

사용자 안내문

이 기기는 업무용 환경에서 사용할 목적으로 적합성평가를 받은 기기로서 가정용 환경에서 사용하는 경우 전파간섭의 우려가 있습니다.

For EU Countries

Manufacturer: Roland Corporation
 2036-1 Nakagawa, Hosoe-cho, Kita-ku, Hamamatsu, Shizuoka 431-1304, JAPAN

Importer: Roland Corporation
 ENA 23 Zone 1 nr. 1620 Klaus-Michael Kuehnelaan 13, 2440 Geel, BELGIUM



Warning: Operation of this equipment in a residential environment could cause radio interference.

For the U.K.

Manufacturer: Roland Corporation
 2036-1 Nakagawa, Hosoe-cho, Kita-ku, Hamamatsu, Shizuoka 431-1304, JAPAN

Importer: Roland Europe Group Limited
 Hive 2, 1530 Arlington Business Park, Theale, Reading, Berkshire. RG7 4SA United Kingdom



Warning: Operation of this equipment in a residential environment could cause radio interference.



Roland Service Centers and Distributors

When you need repair service, access this URL and find your nearest Roland Service Center or authorized Roland distributor in your country.

<https://roland.cm/service>



* 5 1 0 0 0 2 9 2 2 6 - 0 4 *